



# **DEEP SEA ELECTRONICS PLC**

## **DSE60xx Series Control Module**

**Document Number 057-112**

Author : Anthony Manton



Deep Sea Electronics Plc  
Highfield House  
Hunmanby  
North Yorkshire  
YO14 0PH  
ENGLAND

Sales Tel: +44 (0) 1723 890099  
Sales Fax: +44 (0) 1723 893303

E-mail: [sales@deepseapl.com](mailto:sales@deepseapl.com)  
Website: [www.deepseapl.com](http://www.deepseapl.com)

### DSE Model 60xx series Control and Instrumentation System Operators Manual

© Deep Sea Electronics Plc

All rights reserved. No part of this publication may be reproduced in any material form (including photocopying or storing in any medium by electronic means or other) without the written permission of the copyright holder except in accordance with the provisions of the Copyright, Designs and Patents Act 1988.

Applications for the copyright holder's written permission to reproduce any part of this publication should be addressed to Deep Sea Electronics Plc at the address above.

The DSE logo and the names are UK registered trademarks of Deep Sea Electronics PLC.



Any reference to trademarked product names used within this publication is owned by their respective companies.

Deep Sea Electronics Plc reserves the right to change the contents of this document without prior notice.

### Amendments since last publication

Amd. No.	Comments
Issue 1	First release
Issue 2	Added fast loading and changes to flexible sensor alarms in the front panel configuration table.
Issue 3	Added Power pages front panel Watts / kVA / kVAr
Issue 4	Added some new output sources
Issue 5	Amended output list.
Issue 6	Amended Dimensions and Panel Cutout

### Clarification of notation used within this publication.

 <b>NOTE:</b>	Highlights an essential element of a procedure to ensure correctness.
 <b>CAUTION!</b>	Indicates a procedure or practice, which, if not strictly observed, could result in damage or destruction of equipment.
 <b>WARNING!</b>	Indicates a procedure or practice, which could result in injury to personnel or loss of life if not followed correctly.

**TABLE OF CONTENTS**

<b>Section</b>	<b>Page</b>
<b>1 BIBLIOGRAPHY.....</b>	<b>5</b>
1.1 INSTALLATION INSTRUCTIONS.....	5
1.2 MANUALS.....	5
<b>2 INTRODUCTION .....</b>	<b>5</b>
<b>3 SPECIFICATIONS .....</b>	<b>6</b>
3.1 PART NUMBERING.....	6
3.1.1 SHORT NAMES .....	6
3.1 POWER SUPPLY REQUIREMENTS .....	7
3.2 TERMINAL SPECIFICATION.....	7
3.3 GENERATOR VOLTAGE / FREQUENCY SENSING.....	7
3.4 INPUTS.....	8
3.4.1 DIGITAL INPUTS .....	8
3.4.2 ANALOGUE INPUTS.....	8
3.4.3 CHARGE FAIL INPUT .....	9
3.4.4 MAGNETIC PICKUP .....	9
3.5 OUTPUTS.....	9
3.5.1 OUTPUTS A & B (FUEL AND START) .....	9
3.5.2 CONFIGURABLE OUTPUTS C, D, E & F.....	9
3.6 COMMUNICATION PORTS .....	9
3.7 ACCUMULATED INSTRUMENTATION.....	9
3.8 DIMENSIONS AND MOUNTING .....	10
3.8.1 DIMENSIONS.....	10
3.8.2 PANEL CUTOUT .....	10
3.8.3 WEIGHT.....	10
3.8.4 FIXING CLIPS .....	10
3.8.5 OPTIONAL SILICON SEALING GASKET .....	10
3.9 APPLICABLE STANDARDS.....	11
<b>4 INSTALLATION.....</b>	<b>12</b>
4.1 TERMINAL DESCRIPTION.....	12
4.1.1 DC SUPPLY, FUEL AND START OUTPUTS.....	12
4.1.2 ANALOGUE SENSORS .....	13
4.1.3 MAGNETIC PICKUP .....	13
4.1.4 CAN.....	14
4.1.5 GENERATOR / MAINS VOLTAGE SENSING .....	14
4.1.6 GENERATOR CURRENT TRANSFORMERS .....	15
4.1.7 DIGITAL INPUTS .....	16
4.1.8 PC CONFIGURATION INTERFACE CONNECTOR .....	16
4.2 TYPICAL WIRING DIAGRAMS.....	17
4.2.1 DSE 6010 MK2 AUTOSTART MODULE.....	17
4.2.2 DSE 6020 MK2 AUTO MAINS FAILURE MODULE .....	18
<b>5 DESCRIPTION OF CONTROLS .....</b>	<b>19</b>
5.1 QUICKSTART GUIDE.....	20
5.1.1 STARTING THE ENGINE.....	20
5.1.2 STOPPING THE ENGINE .....	20
5.2 GRAPHICAL DISPLAY .....	21
5.3 VIEWING THE INSTRUMENTS .....	21
5.4 EVENT LOG .....	22
5.5 CONTROLS.....	23
<b>6 OPERATION.....</b>	<b>24</b>
6.1 AUTOMATIC MODE OF OPERATION.....	24
6.1.1 WAITING IN AUTO MODE.....	24

6.1.2	STARTING SEQUENCE .....	24
6.1.3	ENGINE RUNNING .....	25
6.1.4	STOPPING SEQUENCE .....	25
<b>6.2</b>	<b>MANUAL OPERATION.....</b>	<b>26</b>
6.2.1	WAITING IN MANUAL MODE .....	26
6.2.2	STARTING SEQUENCE .....	26
6.2.3	ENGINE RUNNING .....	27
6.2.4	STOPPING SEQUENCE .....	27
<b>6.3</b>	<b>TEST MODE.....</b>	<b>28</b>
6.3.1	WAITING IN TEST MODE .....	28
6.3.2	STARTING SEQUENCE .....	28
6.3.3	ENGINE RUNNING .....	29
<b>7</b>	<b>MODULE DISPLAY.....</b>	<b>30</b>
7.1	BACKLIGHT .....	30
7.2	GRAPHICAL DISPLAY .....	30
7.2.1	DISPLAY EXAMPLE.....	30
7.2.2	MODE ICON .....	30
7.2.3	AUTO RUN ICON.....	31
7.2.4	INSTRUMENTATION ICONS .....	31
7.2.5	ACTIVE CONFIGURATION.....	32
7.3	PROTECTIONS .....	33
7.4	WARNINGS .....	34
7.5	SHUTDOWN ALARMS .....	35
7.6	ELECTRICAL TRIP ALARMS.....	37
<b>8</b>	<b>FRONT PANEL CONFIGURATION.....</b>	<b>38</b>
8.1	ACCESSING THE FRONT PANEL EDITOR (FPE) .....	38
8.2	EDITING A PARAMETER.....	38
8.3	ADJUSTABLE PARAMETERS .....	39
<b>9</b>	<b>COMMISSIONING.....</b>	<b>52</b>
9.1.1	PRE-COMMISSIONING .....	52
<b>10</b>	<b>FAULT FINDING .....</b>	<b>53</b>
<b>11</b>	<b>MAINTENANCE, SPARES, REPAIR AND SERVICING .....</b>	<b>55</b>
11.1	PURCHASING ADDITIONAL CONNECTOR PLUGS FROM DSE .....	55
11.1.1	DSE6010.....	55
11.1.2	DSE6020.....	55
11.2	PURCHASING ADDITIONAL FIXING CLIPS FROM DSE.....	55
11.3	PURCHASING SEALING GASKET FROM DSE .....	56
<b>12</b>	<b>WARRANTY.....</b>	<b>57</b>
<b>13</b>	<b>DISPOSAL .....</b>	<b>57</b>
13.1	WEEE (WASTE ELECTRICAL AND ELECTRONIC EQUIPMENT).....	57
13.2	ROHS (RESTRICTION OF HAZARDOUS SUBSTANCES).....	57
<b>14</b>	<b>APPENDIX .....</b>	<b>58</b>
14.1	CAN INTERFACE.....	58
14.2	COMMUNICATIONS OPTION CONNECTIONS.....	59
14.2.1	DESCRIPTION.....	59
14.2.2	PC TO CONTROLLER (DIRECT) CONNECTION .....	59
14.3	ENCLOSURE CLASSIFICATIONS.....	60

# 1 BIBLIOGRAPHY

## 1.1 INSTALLATION INSTRUCTIONS

DSE PART	DESCRIPTION
053-076	6010 installation instructions
053-077	6020 installation instructions

## 1.2 MANUALS

DSE PART	DESCRIPTION
057-004	Electronic Engines and DSE wiring
057-114	DSE60xx Config Suite Manual

# 2 INTRODUCTION

This document details the installation and operation requirements of the DSE60xx, part of the DSEUltra® range of products. DSE6100 series modules are not covered in this document.

The manual forms part of the product and should be kept for the entire life of the product. If the product is passed or supplied to another party, ensure that this document is passed to them for reference purposes.

This is not a *controlled document*. You will not be automatically informed of updates. Any future updates of this document will be included on the DSE website at [www.deepseapl.com](http://www.deepseapl.com)

The **DSE 60xx series** module has been designed to allow the operator to start and stop the engine/generator, and if required, transfer the load.

The user also has the facility to view the system operating parameters via the LCD display.

The **DSE 60xx** module monitors the engine, indicating the operational status and fault conditions, automatically shutting down the engine and giving a true first up fault condition of an engine failure. The LCD display indicates the fault.

The powerful microprocessor contained within the module allows for incorporation of a range of enhanced features:

- *Text based LCD display*
- **True RMS** Voltage monitoring with 3 phase generator sensing (Mk2 models only)
- *Engine parameter monitoring.*
- *Fully configurable inputs for use as alarms or a range of different functions.*
- *Engine ECU interface to **electronic engines** (specify on ordering)*
- *Magnetic pickup interface for engine only applications (specify on ordering)*

Using a PC and the 60xx series configuration software allows alteration of selected operational sequences, timers and alarm trips.

Additionally, the module's integral fascia configuration editor allows full adjustment of all this information.

A robust plastic case designed for front panel mounting houses the module. Connections are via locking plug and sockets.

### 3 SPECIFICATIONS

#### 3.1 PART NUMBERING

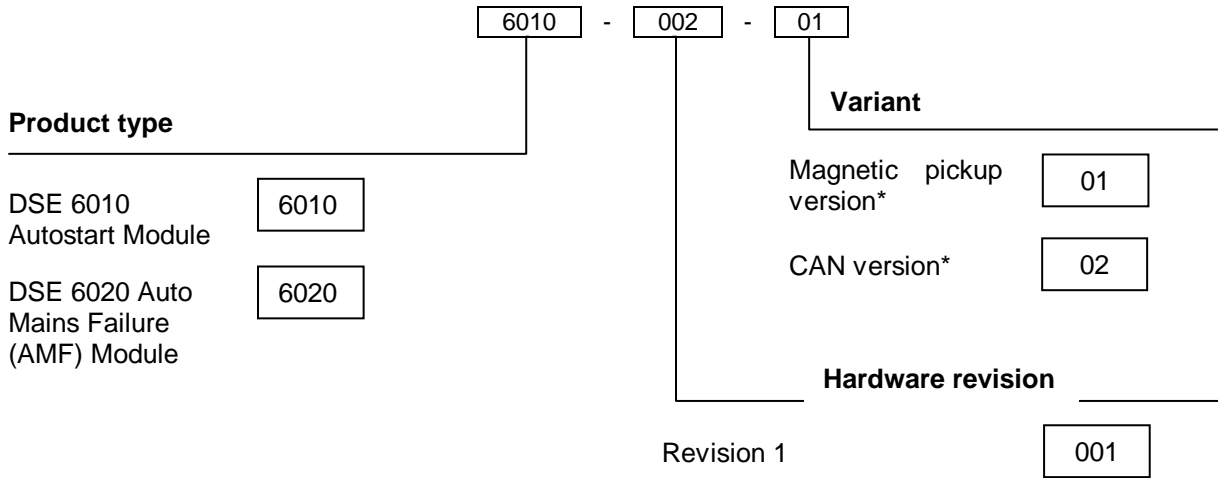

**NOTE\*:-**

**Variant 01** has optional Magnetic Pickup input in the case of an engine only application. When the engine is fitted with a main AC alternator, the engine speed can be derived from the main AC alternator output.

**Variant 02** is only suitable for CAN enabled engines (with CAN engine control unit (ECU))

#### 3.1.1 SHORT NAMES

Short name	Description
60xx	DSE 60xx series control module
60x0-xxx-01	6010 or 6020 MPU version module
60x0-xxx-02	6010 or 6020 CAN version module

### 3.1 POWER SUPPLY REQUIREMENTS

Minimum supply voltage	8V continuous
Cranking dropouts	Able to survive 0V for 50mS providing the supply was at least 10V before the dropout and recovers to 5V afterwards.
Maximum supply voltage	35V continuous (60V protection)
Reverse polarity protection	-35V continuous
Maximum operating current (all inputs and sensor active)	146mA at 12V, 79mA at 24V
Nominal standby current (no inputs active)	72mA at 12V, 42mA at 24V
Power Save Mode Active	43mA at 12V, 28mA at 24V

#### Plant supply instrumentation display

Range	0V-60V DC (note Maximum continuous operating voltage of 35V DC)
Resolution	0.1V
Accuracy	1% full scale

### 3.2 TERMINAL SPECIFICATION

Connection type	Screw terminal, rising clamp, no internal spring
Min cable size	0.5mm <sup>2</sup> (AWG 24)
Max cable size	2.5mm <sup>2</sup> (AWG 10)

### 3.3 GENERATOR VOLTAGE / FREQUENCY SENSING

Measurement type	True RMS conversion
Sample Rate	5KHz or better
Harmonics	Up to 11 <sup>th</sup> or better
Input Impedance	300K $\Omega$ ph-N
Phase to Neutral	15V to 333V AC (max)
Phase to Phase	25V to 576V AC (max)
Common mode offset from Earth	100V AC (max)
Resolution	1V AC phase to neutral 2V AC phase to phase
Accuracy	$\pm$ 1% of full scale phase to neutral $\pm$ 2% of full scale phase to phase
Minimum frequency	3.5Hz
Maximum frequency	75.0Hz
Frequency resolution	0.1Hz
Frequency accuracy	$\pm$ 0.2Hz

### 3.4 INPUTS

#### 3.4.1 DIGITAL INPUTS

Number	4
Arrangement	Contact between terminal and ground
Low level threshold	40% of DC supply voltage
High level threshold	60% of DC supply voltage
Maximum input voltage	DC supply voltage positive terminal
Minimum input voltage	DC supply voltage negative terminal
Contact wetting current	2.5mA @ 12V typical 5mA @ 24V typical
Open circuit voltage	Plant supply

#### 3.4.2 ANALOGUE INPUTS

##### Oil Pressure

Measurement type	Resistance measurement by measuring voltage across sensor with a fixed current applied
Arrangement	Differential resistance measurement input
Measurement current	15mA
Full scale	240Ω
Over range / fail	350Ω
Resolution	1-2 PSI (0.1 Bar)
Accuracy	±2% of full scale resistance (±4.8Ω) excluding transducer error
Max common mode voltage	±2V
Display range	0-200 PSI (13.7 bar) subject to limits of the sensor

##### Coolant Temperature

Measurement type	Resistance measurement by measuring voltage across sensor with a fixed current applied
Arrangement	Differential resistance measurement input
Measurement current	10mA
Full scale	480Ω
Over range / fail	2kΩ (2000Ω)
Resolution	1°C, 2°F
Accuracy	±2% of full scale resistance (±9.6Ω) excluding transducer error
Max common mode voltage	±2V
Display range	0°C -140°C (32°F - 284°F) Depending on sensor

##### Flexible Sensor

Measurement type	Resistance measurement by measuring voltage across sensor with a fixed current applied
Arrangement	Differential resistance measurement input
Measurement current	10mA
Full scale	480Ω
Over range / fail	600Ω
Resolution	1%
Accuracy	±2% of full scale resistance (±9.6Ω) excluding transducer error
Max common mode voltage	±2V
Display range	0-250%



### 3.4.3 CHARGE FAIL INPUT

Minimum voltage	0V
Maximum voltage	35V (plant supply)
Resolution	0.2V
Accuracy	± 1% of max measured voltage
Excitation	Active circuit constant power output
Output Power	2.5W nominal at 12V and 24V
Current at 12V	210mA
Current at 24V	105mA

### 3.4.4 MAGNETIC PICKUP

Not applicable to 44x0-xxx-02 CAN version module.

Type	Single ended input, capacitive coupled
Minimum voltage	0.5V RMS
Max common mode voltage	±2V
Maximum voltage	Clamped to ±70V by transient suppressers, dissipation not to exceed 1W.
Maximum frequency	10,000Hz
Resolution	6.25 RPM
Accuracy	±25 RPM
Flywheel teeth	10 to 500

## 3.5 OUTPUTS

### 3.5.1 OUTPUTS A & B (FUEL AND START)

Type	Fuel (A) and Start (B) outputs. Supplied from DC supply terminal 2. Fully configurable when CAN engine is selected.
Rating	2A @ 35V
Protection	Protected against over current & over temperature. Built in load dump feature.

### 3.5.2 CONFIGURABLE OUTPUTS C, D, E & F

Type	Fully configurable, supplied from DC supply terminal 2.
Rating	2A @ 35V
Protection	Protected against over current & over temperature. Built in load dump feature.

## 3.6 COMMUNICATION PORTS

USB Port	USB2.0 Device for connection to PC running DSE configuration suite only
CAN Port (not applicable to 6010-xxx-01 MPU version)	Engine CAN Port Standard implementation of 'Slow mode', up to 250 kbits/s Non Isolated. Internal Termination provided (120Ω)

## 3.7 ACCUMULATED INSTRUMENTATION

 **NOTE : When an accumulated instrumentation value exceeds the maximum number as listed below, it will reset and begin counting from zero again.**

Engine hours run	Maximum 99999 hrs 59 minutes (approximately 11yrs 4months)
Number of starts	1,000,000 (1 million)

## 3.8 DIMENSIONS AND MOUNTING

### 3.8.1 DIMENSIONS

216mm x 158mm x 42mm  
(8.5" x 6.2" x 1.6")

### 3.8.2 PANEL CUTOUT

182mm x 137mm  
(7.2" x 3.9")

### 3.8.3 WEIGHT

400g (0.4kg)

### 3.8.4 FIXING CLIPS

The module is held into the panel fascia using the supplied fixing clips.

- Withdraw the fixing clip screw (turn anticlockwise) until only the pointed end is protruding from the clip.
- Insert the three 'prongs' of the fixing clip into the slots in the side of the 60xx series module case.
- Pull the fixing clip backwards (towards the back of the module) ensuring all three prongs of the clip are inside their allotted slots.
- Turn the fixing clip screws clockwise until they make contact with the panel fascia.
- Turn the screws a little more to secure the module into the panel fascia. Care should be taken not to over tighten the fixing clip screws.

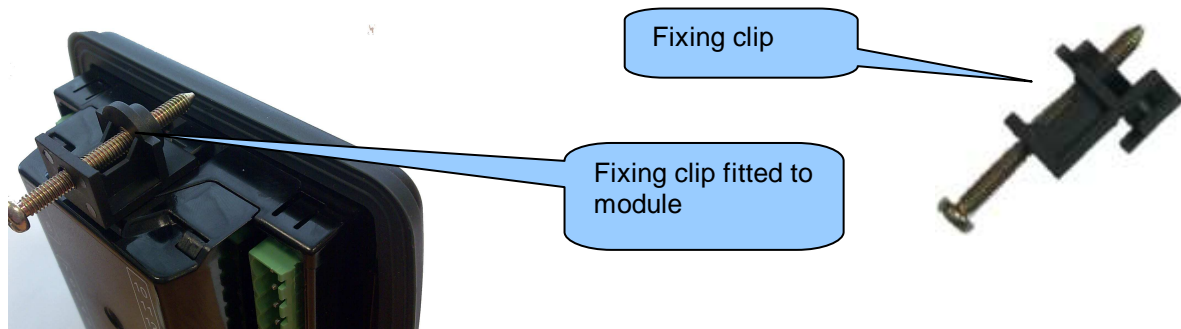

**NOTE:-** In conditions of excessive vibration, mount the panel on suitable anti-vibration mountings.

### 3.8.5 OPTIONAL SILICON SEALING GASKET

The optional silicon gasket provides improved sealing between the 60xx series module and the panel fascia.

The gasket is fitted to the module before installation into the panel fascia.

Take care to ensure the gasket is correctly fitted to the module to maintain the integrity of the seal.

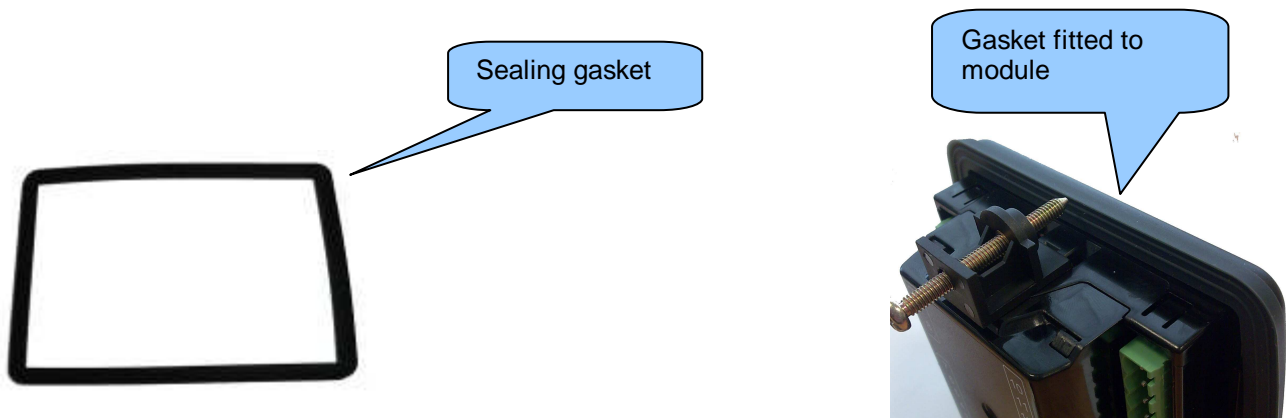

### 3.9 APPLICABLE STANDARDS

<b>BS 4884-1</b>	This document conforms to BS4884-1 1992 Specification for presentation of essential information.
<b>BS 4884-2</b>	This document conforms to BS4884-2 1993 Guide to content
<b>BS 4884-3</b>	This document conforms to BS4884-3 1993 Guide to presentation
<b>BS EN 60068-2-1</b> (Minimum temperature)	-30°C (-22°F)
<b>BS EN 60068-2-2</b> (Maximum temperature)	+70°C (158°F)
<b>BS EN 60950</b>	Safety of information technology equipment, including electrical business equipment
<b>BS EN 61000-6-2</b>	EMC Generic Immunity Standard (Industrial)
<b>BS EN 61000-6-4</b>	EMC Generic Emission Standard (Industrial)
<b>BS EN 60529</b> (Degrees of protection provided by enclosures)	IP65 (front of module when installed into the control panel with the optional sealing gasket) IP42 (front of module when installed into the control panel WITHOUT being sealed to the panel)
<b>UL508</b> <b>NEMA rating</b> (Approximate)	12 (Front of module when installed into the control panel with the optional sealing gasket). 2 (Front of module when installed into the control panel WITHOUT being sealed to the panel)
<b>IEEE C37.2</b> (Standard Electrical Power System Device Function Numbers and Contact Designations)	Under the scope of IEEE 37.2, <i>function numbers can also be used to represent functions in microprocessor devices and software programs.</i> The 60xx series controller is device number 11L-60xx (Multifunction device protecting Line (generator) – 60xx series module).  As the module is configurable by the generator OEM, the functions covered by the module will vary. Under the module's factory configuration, the device numbers included within the module are :  2 – Time delay starting or closing relay 6 – Starting circuit breaker 30 – annunciator relay 42 – Running circuit breaker 54 – turning gear engaging device 62 – time delay stopping or opening relay 63 – pressure switch 74 – alarm relay 81 – frequency relay 86 – lockout relay

In line with our policy of continual development, Deep Sea Electronics, reserve the right to change specification without notice.





## 4 INSTALLATION

The DSE60xx Series module is designed to be mounted on the panel fascia. For dimension and mounting details, see the section entitled *Specification, Dimension and mounting* elsewhere in this document.

 **NOTE:-** Note that these connection details are for Mk2 controllers. Connection details for Mk1 controllers are included in DSE publication 057-092

### 4.1 TERMINAL DESCRIPTION

#### 4.1.1 DC SUPPLY, FUEL AND START OUTPUTS

	PIN No	DESCRIPTION	CABLE SIZE	NOTES
	1	DC Plant Supply Input (Negative)	2.5mm <sup>2</sup> AWG 13	
	2	DC Plant Supply Input (Positive)	2.5 mm <sup>2</sup> AWG 13	(Recommended Maximum Fuse 15A anti-surge) Supplies the module (2A anti-surge requirement) and all output relays
	3	Emergency Stop	1.0mm <sup>2</sup> AWG 18	Plant Supply Positive from terminal 2. 3 Amp rated.
	4	Output A	1.0mm <sup>2</sup> AWG 18	Plant Supply Positive from terminal 2. 3 Amp rated. Normally used for FUEL control.
	5	Output B	1.0mm <sup>2</sup> AWG 18	Plant Supply Positive from terminal 2. 3 Amp rated. Normally used for START control.
<b>D+ W/L</b>	6	Charge fail / excite	2.5mm <sup>2</sup> AWG 13	Do not connect to ground (battery negative). If charge alternator is not fitted, leave this terminal disconnected.
	7	System Earth	1.0mm <sup>2</sup> AWG 18	
	8	Output C	1.0mm <sup>2</sup> AWG 18	Plant Supply Positive from terminal 2. 3 Amp rated. Normally used for Generator load switch control.
	9	Output D	1.0mm <sup>2</sup> AWG 18	Plant Supply Positive from terminal 2. 3 Amp rated. Normally used for Mains load switch control (DSE6020)
	10	Output E	1.0mm <sup>2</sup> AWG 18	Plant Supply Positive from terminal 2. 3 Amp rated.
	11	Output F	1.0mm <sup>2</sup> AWG 18	Plant Supply Positive from terminal 2. 3 Amp rated.

 **NOTE:-** When the module is configured for operation with an electronic engine, FUEL and START output requirements may be different. Refer to *Electronic Engines and DSE Wiring* for further information. DSE Part No. 057-004.

## 4.1.2 ANALOGUE SENSORS

	PIN No	DESCRIPTION	CABLE SIZE	NOTES
	12	Sensor Common Return	0.5mm <sup>2</sup> AWG 20	Return feed for sensors*
	13	Oil Pressure Input	0.5mm <sup>2</sup> AWG 20	Connect to Oil pressure sensor
	14	Coolant Temperature Input	0.5mm <sup>2</sup> AWG 20	Connect to Coolant Temperature sensor
	15	Flexible Sensor Input	0.5mm <sup>2</sup> AWG 20	Connect to sensor

**NOTE:-** . It is VERY important that terminal 12 (sensor common) is soundly connected to an earth point on the ENGINE BLOCK, not within the control panel, and must be a sound electrical connection to the sensor bodies. This connection MUST NOT be used to provide an earth connection for other terminals or devices. The simplest way to achieve this is to run a SEPERATE earth connection from the system earth star point, to terminal 12 directly, and not use this earth for other connections.

**NOTE:-** . If you use PTFE insulating tape on the sensor thread when using earth return sensors, ensure you do not insulate the entire thread, as this will prevent the sensor body from being earthed via the engine block.

## 4.1.3 MAGNETIC PICKUP

	PIN No	DESCRIPTION	CABLE SIZE	NOTES
	16	Magnetic pickup Positive	0.5mm <sup>2</sup> AWG 20	Connect to Magnetic Pickup device
	17	Magnetic pickup Negative	0.5mm <sup>2</sup> AWG 20	Connect to Magnetic Pickup device
	18	Magnetic pickup screen	0.5mm <sup>2</sup> AWG 20	Do not connect the other end to earth!

**NOTE:-** Magnetic Pickup interface is not fitted to the 6010-xx-00 module

**NOTE:-** Screened cable must be used for connecting the Magnetic Pickup, ensuring that the screen is earthed at one end ONLY.



#### 4.1.4 CAN

	PIN No	DESCRIPTION	CABLE SIZE	NOTES
	16	CAN port H	0.5mm <sup>2</sup> AWG 20	Use only 120Ω CAN approved cable
	17	CAN port L	0.5mm <sup>2</sup> AWG 20	Use only 120Ω CAN approved cable
	18	CAN port Common	0.5mm <sup>2</sup> AWG 20	Use only 120Ω CAN approved cable

 **NOTE:- CAN interface is not fitted to the 6010-xx-01 module**

 **NOTE:- Screened 120Ω impedance cable specified for use with CAN must be used for the CAN link and the Multiset comms link. DSE stock and supply Belden cable 9841 which is a high quality 120Ω impedance cable suitable for CAN use (DSE part number 016-030)**

#### 4.1.5 GENERATOR / MAINS VOLTAGE SENSING

	PIN No	DESCRIPTION	CABLE SIZE	NOTES
	19	Generator L1 (U) voltage monitoring	1.0mm <sup>2</sup> AWG 18	Connect to generator L1 (U) output (AC) (Recommend 2A fuse)
	20	Generator L2 (V) voltage monitoring	1.0mm <sup>2</sup> AWG 18	Connect to generator L2 (V) output (AC) (Recommend 2A fuse)
	21	Generator L3 (W) voltage monitoring	1.0mm <sup>2</sup> AWG 18	Connect to generator L3 (W) output (AC) (Recommend 2A fuse)
	22	Generator Neutral (N) input	1.0mm <sup>2</sup> AWG 18	Connect to generator Neutral terminal (AC)
	23	Mains L1 (R) voltage monitoring	1.0mm <sup>2</sup> AWG 18	Connect to Mains L1 (R) output (AC) (Recommend 2A fuse)
	24	Mains L2 (S) voltage monitoring	1.0mm <sup>2</sup> AWG 18	Connect to Mains L2 (S) output (AC) (Recommend 2A fuse)
	25	Mains L3 (T) voltage monitoring	1.0mm <sup>2</sup> AWG 18	Connect to Mains L3 (T) output (AC) (Recommend 2A fuse)
	26	Mains Neutral (N) input	1.0mm <sup>2</sup> AWG 18	Connect to Mains Neutral terminal (AC)

 **NOTE:- Terminals 23-26 are not fitted to the DSE6010.**

#### 4.1.6 GENERATOR CURRENT TRANSFORMERS

**⚠ WARNING!:-** Do not disconnect this plug when the CTs are carrying current. Disconnection will open circuit the secondary of the C.T.'s and dangerous voltages may then develop. Always ensure the CTs are not carrying current and the CTs are short circuit connected before making or breaking connections to the module.

**⚠ NOTE:-** The 6000 series module has a burden of 0.5VA on the CT. Ensure the CT is rated for the burden of the 6000 series controller, the cable length being used and any other equipment sharing the CT. If in doubt, consult your CT supplier.

**⚠ NOTE:-** Take care to ensure correct polarity of the CT primary as shown below. If in doubt, check with the CT supplier.

#### CT LABELLING

p1,  $\xi$  or K is the primary of the CT that 'points' towards the GENERATOR

p2,  $\ell$  or L is the primary of the CT that 'points' towards the LOAD

s1 is the secondary of the CT that connects to the DSE Module's input for the CT measuring (I1,I2,I3)

s2 is the secondary of the CT that should be commoned with the s2 connections of all the other CTs and connected to the CT common terminal of the DSE6000 series modules.

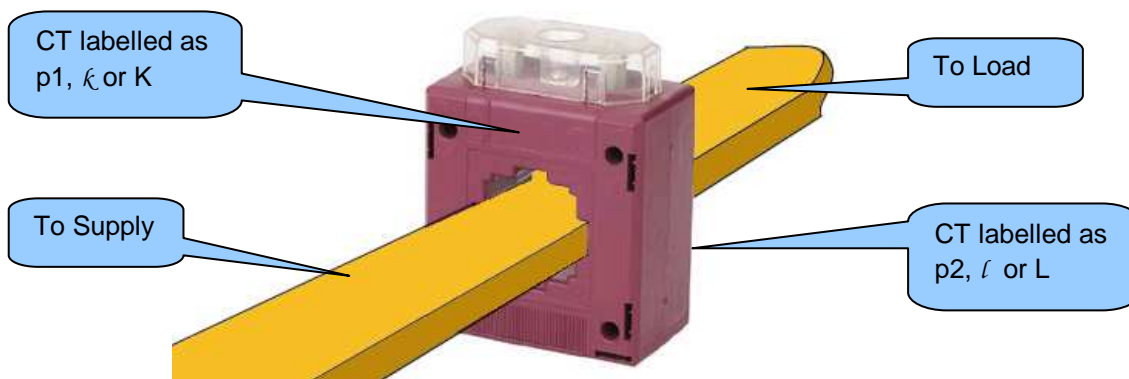

	27	Generator I1 Current Transformer	1.0mm <sup>2</sup> AWG 18	Connect to generator CT 1 (s1)
	28	Generator I2 Current Transformer	1.0mm <sup>2</sup> AWG 18	Connect to generator CT 2 (s1)
	29	Generator I3 Current Transformer	1.0mm <sup>2</sup> AWG 18	Connect to generator CT 3 (s1)
	30	Generator Current Transformer common connection	1.0mm <sup>2</sup> AWG 18	Connect to generator CT common (s2)
	31			



**⚠ NOTE:-** Terminals 30 and 31 are internally connected to each other.

#### 4.1.7 DIGITAL INPUTS

	PIN No	DESCRIPTION	CABLE SIZE	NOTES
	32	Configurable digital input A	0.5mm <sup>2</sup> AWG 20	Switch to negative
	33	Configurable digital input B	0.5mm <sup>2</sup> AWG 20	Switch to negative
	34	Configurable digital input C	0.5mm <sup>2</sup> AWG 20	Switch to negative
	35	Configurable digital input D	0.5mm <sup>2</sup> AWG 20	Switch to negative

This configuration cable is the same as normally used between a PC and a USB printer.

#### 4.1.8 PC CONFIGURATION INTERFACE CONNECTOR

	DESCRIPTION	CABLE SIZE	NOTES
	Socket for connection to PC with DSE Configuration Suite PC software.	0.5mm <sup>2</sup> AWG 20	This is a standard USB type A to type B cable. 

**NOTE:-** The USB connection cable between the PC and the 6000 series module must not be extended beyond 5m (5yds). For distances over 5m, it is possible to use a third party USB extender. Typically, they extend USB up to 50m (yds). The supply and support of this type of equipment is outside the scope of Deep Sea Electronics PLC.

**CAUTION!** Care must be taken not to overload the PC's USB system by connecting more than the recommended number of USB devices to the PC. For further information, consult your PC supplier.

**CAUTION!** This socket must not be used for any other purpose.



## 4.2 TYPICAL WIRING DIAGRAMS

### 4.2.1 DSE 6010 AUTOSTART MODULE

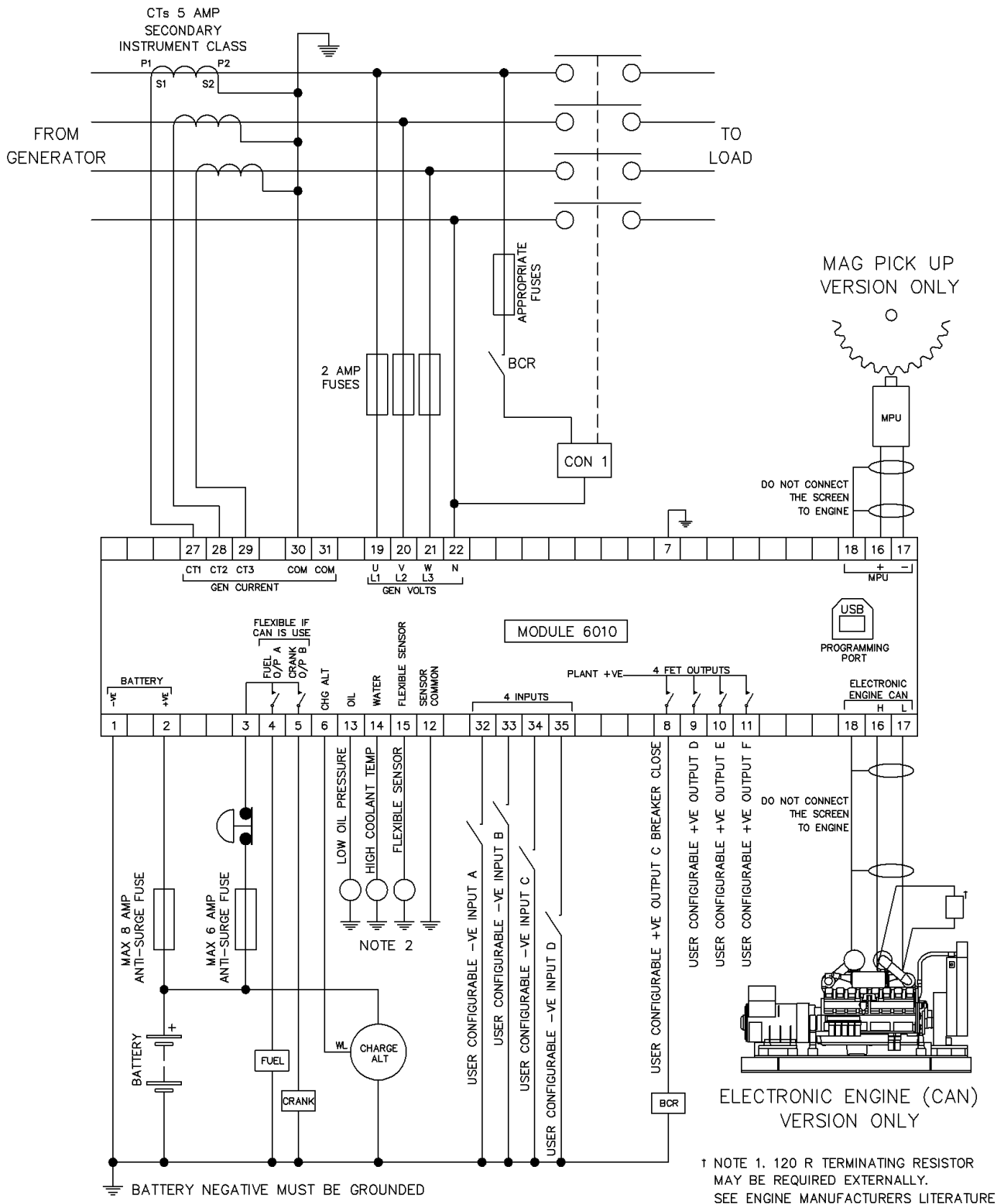

4.2.2 DSE 6020 AUTO MAINS FAILURE MODULE

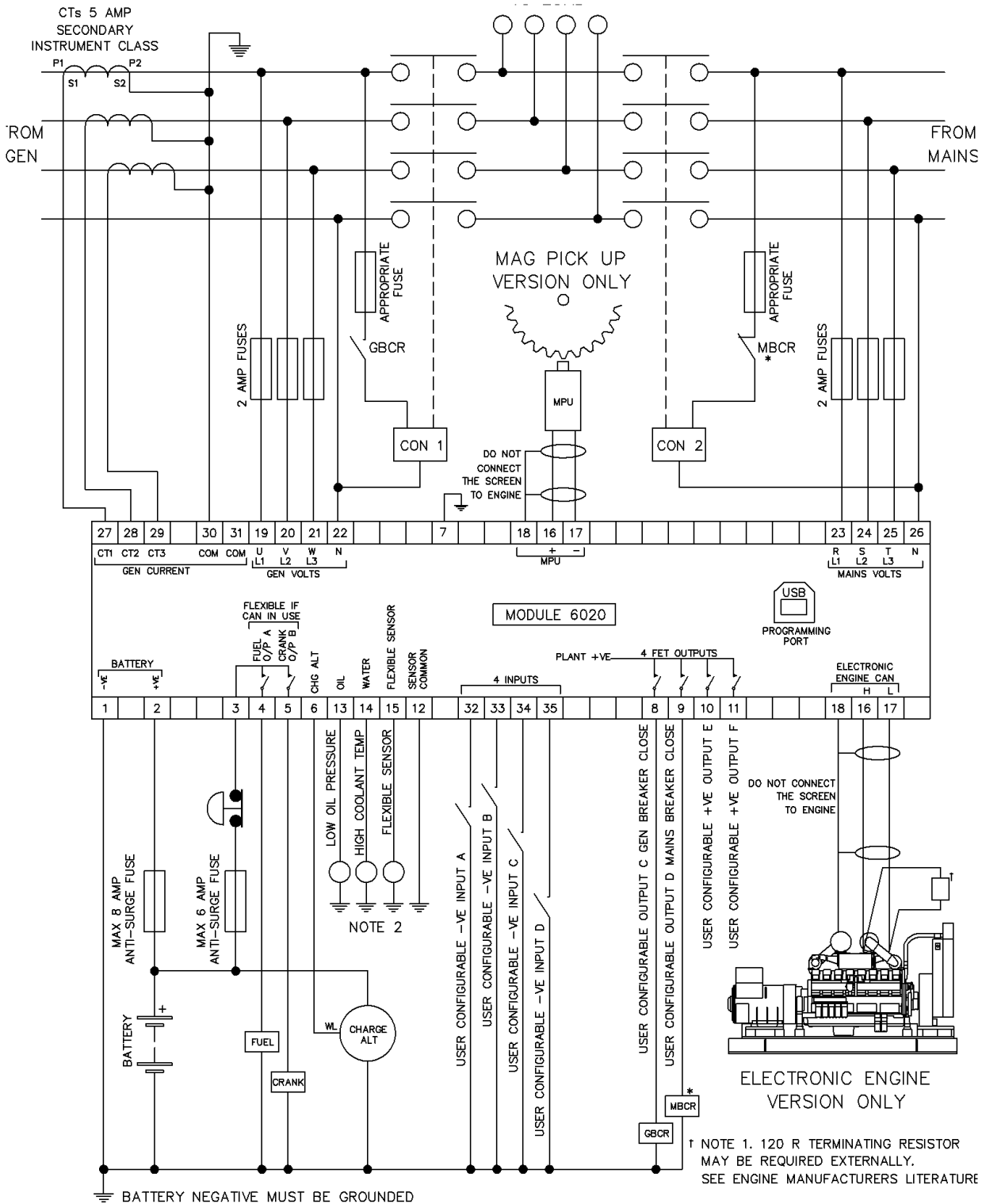

TERMINALS SUITABLE FOR 22-16 AWG (0.6mm - 1.3mm ) FIELD WIRING  
TIGHTENING TORQUE = 0.8Nm (7lb-in)

NOTE 2  
THESE GROUND CONNECTIONS MUST BE ON THE ENGINE BLOCK, AND MUST BE TO THE SENDER BODIES.

\* NOTE 3. MAINS BREAKER CLOSED OUTPUT SHOULD BE CONFIGURED FOR DE-ENERGISE CLOSE MAINS, AND USE THE NORMALLY CLOSED CONTACTS OF MBCR

## 5 DESCRIPTION OF CONTROLS

The following section details the function and meaning of the various controls on the module.

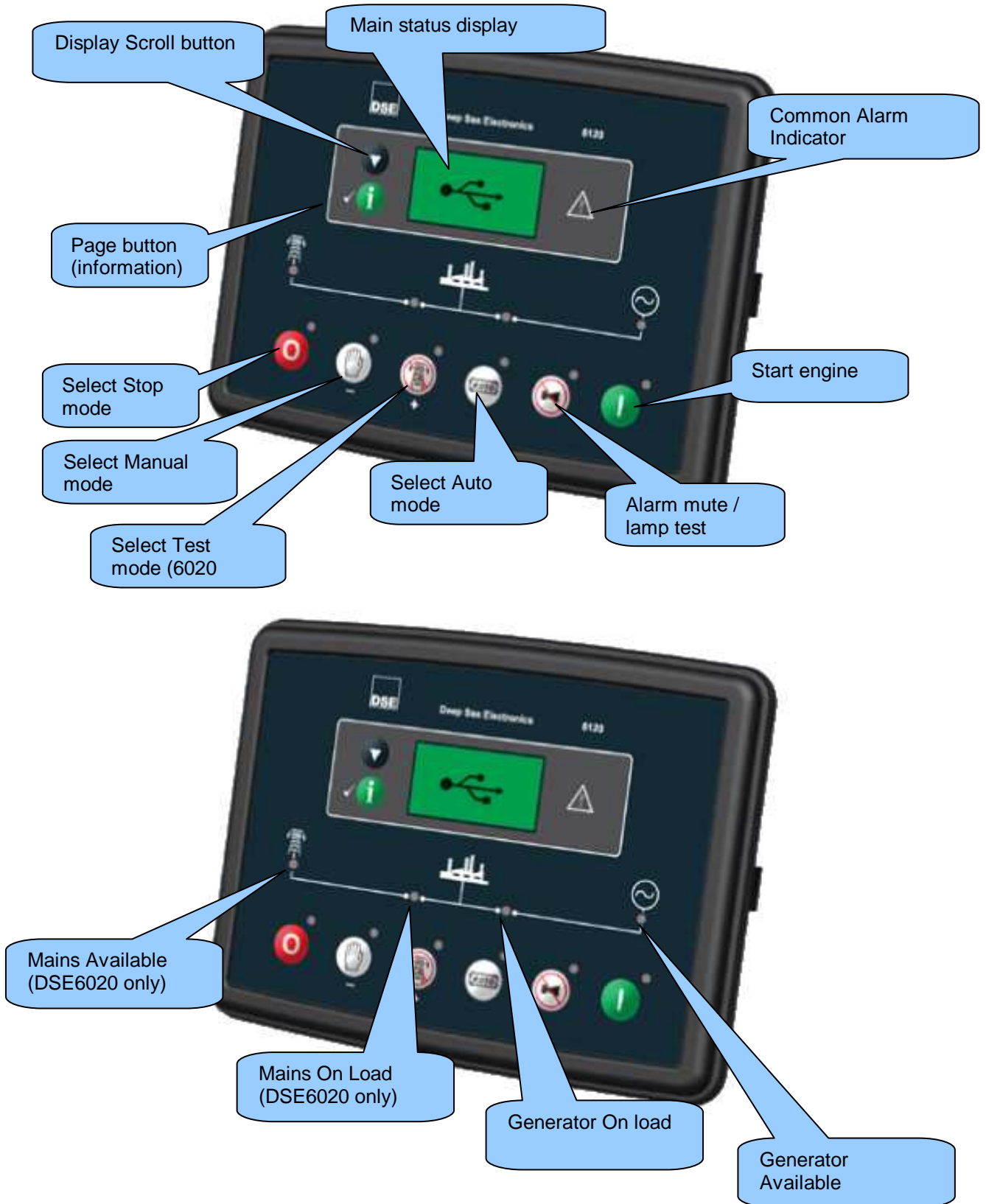

## 5.1 QUICKSTART GUIDE

This section provides a quick start guide to the module's operation.

### 5.1.1 STARTING THE ENGINE

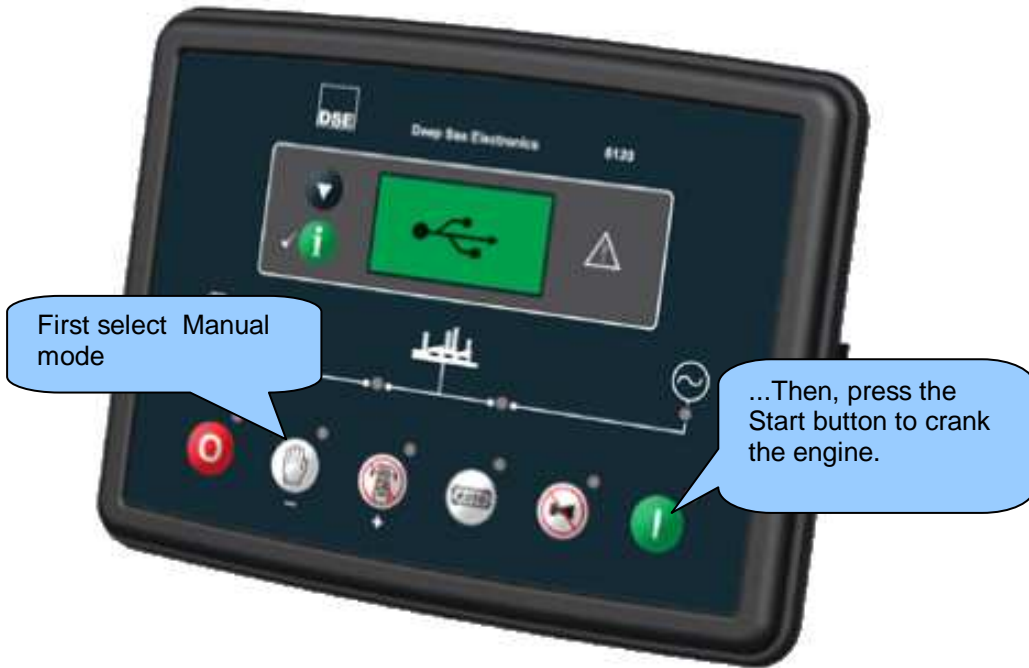

**NOTE:-** For further details, see the section entitled 'OPERATION' elsewhere in this manual.

### 5.1.2 STOPPING THE ENGINE



**NOTE:-** For further details, see the section entitled 'OPERATION' elsewhere in this manual.

## 5.2 GRAPHICAL DISPLAY

- 4- line, 64 x 132 small Graphic Display with LED Backlight
- Icon and numeric display.
- Software controlled contrast
- Mimic of 4 x indicators via LCD

## 5.3 VIEWING THE INSTRUMENTS

At power up, the display will show the software version and then show the default screen, which will display Generator Frequency.

It is possible to scroll to display the different pages of information by repeatedly operating the down button 

Pressing the information  button toggles between instrumentation and event log displays

Once selected the page will remain on the LCD display until the user selects a different page or after an extended period of inactivity, the module will revert to the status display.



When scrolling manually by pressing the  button, the display will automatically return to the Status page if no buttons are pressed for the duration of the configurable *LCD Page Timer*.

If an alarm becomes active while viewing the status page, the display shows the Alarms page to draw the operator's attention to the alarm condition.

Metering:

- Generator Voltage, 3-phase, L-L and L-N
- Generator Frequency
  
- Mains Voltage, 3-phase, L-L and L-N (Model 6020 only)
- Mains Voltage, 3-phase, L-L and L-N (Model 6020 only)
- Mains Frequency
  
- Generator Current
- Generator kW L1 L2 L3
- Generator KW
- Generator kVA L1 L2 L3
- Generator kVA
- Generator kV Ar L1 L2 L3
- Generator kV Ar
- Power Factor pf L1 L2 L3
- Power Factor pf
- Power kWh kV Arh kV Ah
  
- Battery Voltage
- Engine hours Run
- Oil Pressure Gauge
- Engine Temperature Gauge
- Fuel Level

## 5.4 EVENT LOG







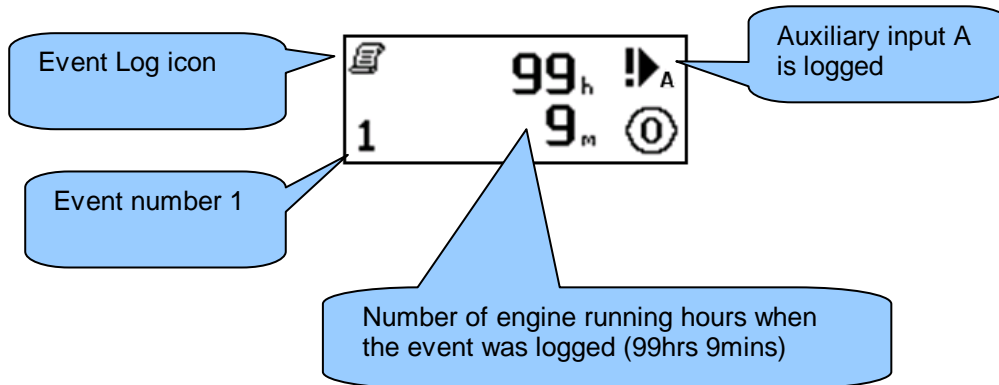



The info  button toggles between the display of the instrumentation and the event log. Pressing the down  button will move to the previous event, the event log entry at position 1 being the most recent. On moving from the instrumentation value to the event log the unit will display the most recent entry.

A number in the bottom left indicates the event log entry currently displayed. There are five event log entries in the 60xx units. When the event log is displayed the icon in the alarm icon area indicates the alarm type at that position of the event log. The hours run at the time of the alarm shows in the instrumentation area. The bottom right icon indicates the current mode as normal.

Example of Auxiliary Input Shutdown Alarm.





## 5.5 CONTROLS

<p><b>Stop / Reset and Manual</b>                  This button places the module into its <b>Stop/Reset</b> and <b>Manual</b> mode. This will clear any alarm conditions for which the triggering criteria have been removed. If the engine is running and the module is in Stop mode, the module will automatically instruct the changeover device to unload the generator (<b>'Close Generator'</b> becomes <i>inactive (if used)</i>). The fuel supply de-energises and the engine comes to a standstill. Should a <b>remote start signal</b> be present while operating in this mode, a remote start will <u>not</u> occur.</p> <p>Once in <b>Manual mode</b> the module will respond to the start  button, start the engine, and run off load. If the engine is running off-load in the <b>Manual mode</b> and a <b>remote start signal</b> becomes present, the module will automatically instruct the changeover device to place the generator on load (<b>'Close Generator'</b> becomes <i>active (if used)</i>). Upon removal of the <b>remote start signal</b>, the generator remains on load until either selection of the <b>'STOP/RESET'</b> or <b>'AUTO'</b> modes.  <i>For further details, please see the more detailed description of 'Manual operation' elsewhere in this manual.</i></p>	
<p><b>Auto</b>                  This button places the module into its <b>'Automatic'</b> mode. This mode allows the module to control the function of the generator automatically. The module will monitor the <i>remote start</i> input and mains supply status and once a start request is made, the set will be automatically started and placed on load.                  Upon removal of the starting signal, the module will automatically transfer the load from the generator and shut the set down observing the <i>stop delay</i> timer and <i>cooling</i> timer as necessary. The module will then await the next start event. <i>For further details, please see the more detailed description of 'Auto operation' elsewhere in this manual.</i></p>	
<p><b>Start</b>                  This button is only active in STOP/RESET  or MANUAL  mode.                  Pressing this button in manual or test mode will start the engine and run off load (manual) or on load (test). Pressing this button in STOP/RESET mode will turn on the CAN engine ECU (when correctly configured and fitted to a compatible engine ECU)</p>	
<p><b>Mute / Lamp Test</b>                  This button silences the audible alarm if it is sounding and illuminates all of the LEDs as a lamp test feature/ When correctly configured and fitted to a compatible engine ECU, pressing this button in STOP/RESET mode after pressing the START  button (to power the ECU) will cancel any "passive" alarms on the engine ECU.</p>	
<p><b>Scroll</b>                  This buttons scrolls through the instruments in the currently displayed page</p>	
<p><b>Page</b>                  Toggles the display between instrumentation an event log mode,</p>	

## 6 OPERATION

### 6.1 AUTOMATIC MODE OF OPERATION

**NOTE:-** If a digital input configured to *panel lock* is active, changing module modes will not be possible. Viewing the instruments and event logs is NOT affected by panel lock.





Activate auto mode by pressing the  pushbutton. The  icon is displayed to indicate Auto Mode operation if no alarms are present.

Auto mode will allow the generator to operate fully automatically, starting and stopping as required with no user intervention.

#### 6.1.1 WAITING IN AUTO MODE

If a starting request is made, the starting sequence will begin.

Starting requests can be from the sources shown below. When the engine is running in AUTO mode, an icon is displayed to indicate the reason for the set being run :

Auto run reason	Icon
Remote start input	
Low battery run	
Scheduled run	
Mains failure (6020 only)	

#### 6.1.2 STARTING SEQUENCE

To allow for 'false' start requests, the *start delay* timer begins.

Should all start requests be removed during the *start delay* timer, the unit will return to a stand-by state.

If a start request is still present at the end of the *start delay* timer, the fuel relay is energised and the engine will be cranked.

**NOTE:-** If the unit has been configured for CAN, compatible ECU's will receive the start command via CAN.

If the engine fails to fire during this cranking attempt then the starter motor is disengaged for the *crank rest* duration after which the next start attempt is made. Should this sequence continue beyond the set number of attempts, the start sequence will be terminated and the display shows  **Fail to Start**.

When the engine fires, the starter motor is disengaged. Speed detection is factory configured to be derived from the main alternator output frequency but can additionally be measured from a Magnetic Pickup mounted on the flywheel (Selected by PC using the 60xx series configuration software).

Additionally, rising oil pressure can be used to disconnect the starter motor (but cannot detect underspeed or overspeed).

**NOTE:-** If the unit has been configured for CAN, speed sensing is via CAN.

After the starter motor has disengaged, the *Safety On* timer activates, allowing Oil Pressure, High Engine Temperature, Under-speed, Charge Fail and any delayed Auxiliary fault inputs to stabilise without triggering the fault.



### 6.1.3 ENGINE RUNNING

Once the engine is running and all starting timers have expired, the animated  icon is displayed.

The generator is placed on load if configured to do so.

**▲ NOTE:-The load transfer signal remains inactive until the Oil Pressure has risen. This prevents excessive wear on the engine.**

If all start requests are removed, the *stopping sequence* will begin.

### 6.1.4 STOPPING SEQUENCE

The *return delay* timer operates to ensure that the starting request has been permanently removed and isn't just a short term removal. Should another start request be made during the cooling down period, the set will return on load.

If there are no starting requests at the end of the *return delay* timer, the load is removed from the generator to the mains supply and the *cooling* timer is initiated.

The *cooling* timer allows the set to run off load and cool sufficiently before being stopped. This is particularly important where turbo chargers are fitted to the engine.

After the *cooling* timer has expired, the set is stopped.

## 6.2 MANUAL OPERATION

Activate Manual mode by pressing the  pushbutton. An LED indicator beside the button confirms this action.

Manual mode allows the operator to start and stop the set manually, and if required change the state of the load switching devices.

### 6.2.1 WAITING IN MANUAL MODE

When in manual mode, the set will not start automatically.

To begin the starting sequence, press the  button.

### 6.2.2 STARTING SEQUENCE

 **NOTE:- There is no *start delay* in this mode of operation.**

The fuel relay is energised and the engine is cranked.

 **NOTE:- If the unit has been configured for CAN, compatible ECU's will receive the start command via CAN.**

If the engine fails to fire during this cranking attempt then the starter motor is disengaged for the crank rest duration after which the next start attempt is made. Should this sequence continue beyond the set number of attempts, the start sequence will be terminated and the display shows  Fail to Start.

When the engine fires, the starter motor is disengaged. Speed detection is factory configured to be derived from the main alternator output frequency but can additionally be measured from a Magnetic Pickup mounted on the flywheel (Selected by PC using the 60xx series configuration software).

Additionally, rising oil pressure can be used disconnect the starter motor (but cannot detect underspeed or overspeed).

 **NOTE:- If the unit has been configured for CAN, speed sensing is via CAN.**

After the starter motor has disengaged, the Safety On timer activates, allowing Oil Pressure, High Engine Temperature, Under-speed, Charge Fail and any delayed Auxiliary fault inputs to stabilise without triggering the fault.



### 6.2.3 ENGINE RUNNING

In manual mode, the load is not transferred to the generator unless a 'loading request' is made. A loading request can come from a number of sources :



- Remote start input
- Low battery run
- Scheduled run
- Mains failure (6020 only)

 **NOTE:-The load transfer signal remains inactive until the Oil Pressure has risen. This prevents excessive wear on the engine.**

Once the load has been transferred to the generator, it will not be automatically removed. To manually transfer the load back to the mains (DSE6020) or to remove the load from the generator (DSE6010) either:

- Press the auto mode  button to return to automatic mode. The set will observe all auto mode start requests and stopping timers before beginning the Auto mode stopping sequence.
- Press the stop button 

### 6.2.4 STOPPING SEQUENCE

- In manual mode the set will continue to run until either :
- The stop button  is pressed – The set will immediately stop
- The auto button  is pressed. The set will observe all auto mode start requests and stopping timers before beginning the Auto mode stopping sequence.

## 6.3 TEST MODE

 **NOTE:- Test Mode is only applicable to DSE6020.**

Activate test mode by pressing the  pushbutton. An LED indicator beside the button confirms this action.

Test mode will start the set and transfer the load to the generator to provide a **Test on load** function.

### 6.3.1 WAITING IN TEST MODE

When in test mode, the set will not start automatically.

To begin the starting sequence, press the  button.

### 6.3.2 STARTING SEQUENCE

The set begins to crank.

 **NOTE:- If the unit has been configured for CAN, compatible ECU's will receive the start command via CAN.**

If the engine fails to fire during this cranking attempt then the starter motor is disengaged for the *crank rest* duration after which the next start attempt is made. Should this sequence continue beyond the set number of attempts, the start sequence will be terminated and the display shows **Fail to Start**.

When the engine fires, the starter motor is disengaged. Speed detection is factory configured to be derived from the main alternator output frequency but can additionally be measured from a Magnetic Pickup mounted on the flywheel (Selected by PC using the 6000 series configuration software).

Additionally, rising oil pressure can be used to disconnect the starter motor (but cannot detect underspeed or overspeed).

 **NOTE:- If the unit has been configured for CAN, speed sensing is via CAN.**

After the starter motor has disengaged, the *Safety On* timer activates, allowing Oil Pressure, High Engine Temperature, Under-speed, Charge Fail and any delayed Auxiliary fault inputs to stabilise without triggering the fault.



### 6.3.3 ENGINE RUNNING

Once the engine is running, the *Warm Up* timer, if selected, begins, allowing the engine to stabilise before accepting the load.

Load will be automatically transferred from the mains supply to the generator.

 **NOTE:-The load transfer signal remains inactive until the Oil Pressure has risen. This prevents excessive wear on the engine.**

In test mode, the set will continue to run *on load* until either:

- The *stop button*  is pressed – The set will immediately stop
- The *auto button*  is pressed. The set will observe all auto mode start requests and stopping timers before beginning the *Auto mode stopping sequence*.

## 7 MODULE DISPLAY

### 7.1 BACKLIGHT

The backlight will be on if the unit has sufficient voltage on the power connection while the unit is turned on, unless the unit is in Power Save mode, or if the engine is cranking for which the backlight will be turned off.

### 7.2 GRAPHICAL DISPLAY

A 48x132 pixel LCD is used for the display. The display is segmented into areas for instrumentation, units, alarm icons and various other icons.

Inst. Icon	Instrumentation	Units	Alarm Icon
Active config /FPE, event index	Instrumentation	Units	Mode Icon
	Instrumentation	Units	





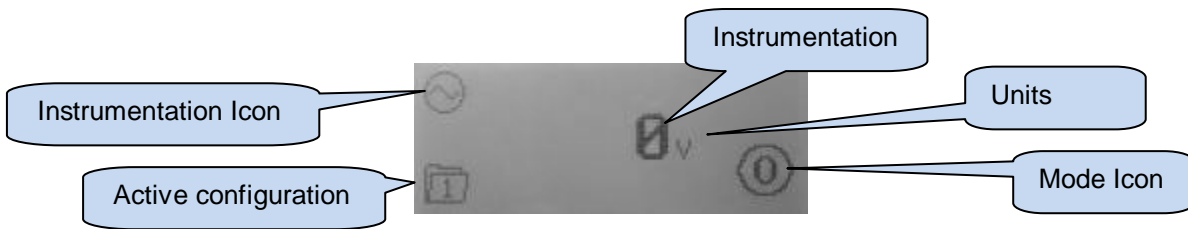

#### 7.2.1 DISPLAY EXAMPLE

This example shows Generator Volts as shown by the Generator  symbol.







#### 7.2.2 MODE ICON

An icon is displayed in the mode icon area of the display to indicate what mode the unit is currently in.

Icon	Graphic	Details
Stopped		Appears when the engine is at rest and the unit is in stop mode.
Auto		Appears when the engine is at rest and the unit is in auto mode.
Manual		Appears when the engine is at rest and the unit is in manual mode/
Timer animation		Appears when a timer is active, for example cranking time, crank rest etc.
Running animation		Appears when the engine is running, and all timers have expired, either on or off load. The animation rate is reduced when running in idle mode.
Front panel editor		Appears when the unit is in the front panel editor.













### 7.2.3 AUTO RUN ICON

When the engine is running in AUTO mode, an icon is displayed to indicate the reason for the set being run.

Auto run reason	Icon
Remote start input	
Low battery run	
Scheduled run	
Mains failure	



### 7.2.4 INSTRUMENTATION ICONS

When displaying instrumentation a small icon is displayed in the instrumentation icon area to indicate what value is currently being displayed.

Icon	Graphic	Details
Generator		Used for generator voltage and generator frequency
Mains		Used for mains voltages and mains frequency
Engine speed		Engine speed instrumentation screen
Hours Run		Hours run instrumentation screen
Battery voltage		Battery voltage instrumentation screen
Engine temperature		Coolant temperature instrumentation screen
Oil pressure		Oil pressure instrumentation screen
Flexible sensor		Flexible sensor instrumentation screen
Event log		Appears when the event log is being displayed
Unit time		Current time held in the unit
Scheduler setting		The current value of the scheduler run time and duration
CAN DTC		ECU diagnostic trouble codes

### 7.2.5 ACTIVE CONFIGURATION

When not in the Front Panel Editor (FPE) mode, and with the alternative configuration enabled, the *active config* area of the display will be used to display the currently active configuration.

Icon	Graphic	Details
Main config		Appears when the main configuration is selected
Alternative config		Appears when the alternative configuration is selected



### **7.3 PROTECTIONS**

When an alarm is present, the Common alarm LED will illuminate.

The LCD display will jump from the 'Information page' to display the Alarm Page. See section entitled Graphical Display for details of alarm icons.

The LCD will display multiple alarms E.g. "High Engine Temperature shutdown", "Emergency Stop" and "Low Coolant Warning". These will automatically scroll round in the order that they occurred;



















In the event of a warning alarm, the LCD will display the appropriate icon. If a shutdown then occurs, the module will again display the appropriate icon, flashing.

## 7.4 WARNINGS

Warnings are non-critical alarm conditions and do not affect the operation of the generator system, they serve to draw the operators attention to an undesirable condition.

In the event of an alarm the LCD will jump to the alarms page, and scroll through all active warnings and shutdowns.

















Warning alarms are self-resetting when the fault condition is removed.

Display		Reason
	Battery High Voltage	The DC supply has risen above the high volts setting level for the duration of the high battery volts timer
	Battery Low Voltage	The DC supply has fallen below the low volts setting level for the duration of the low battery volts timer
	CAN ECU Warning	The engine ECU has detected a warning alarm and has informed the DSE module of this situation. The exact error is also indicated on the module's display.
	Charge Alternator Failure	The auxiliary charge alternator voltage is low as measured from the W/L terminal.
	Digital Input A-D	Auxiliary Digital inputs can be user configured as Digital inputs and will display the relevant icon.
	Analogue Input A-C	Auxiliary Analogue inputs can be user configured as Digital inputs and will display the relevant icon.
	Fail To stop	The module has detected a condition that indicates that the engine is running when it has been instructed to stop. <div style="border: 2px solid black; padding: 5px; margin-top: 10px;"> <b>NOTE:- 'Fail to Stop' could indicate a faulty oil pressure sensor - If engine is at rest check oil sensor wiring and configuration.</b></div>
	Generator High Voltage Warning	The generator output voltage has risen above the pre-set pre-alarm setting.
	Generator Low Voltage Warning	The generator output voltage has fallen below the pre-set pre-alarm setting after the <i>Safety On</i> timer has expired.
	High Coolant Temperature Warning	The module detects that the engine coolant temperature has exceeded the high engine temperature pre-alarm setting level after the <i>Safety On</i> timer has expired.
	Low Oil Pressure Warning	The module detects that the engine oil pressure has fallen below the low oil pressure pre-alarm setting level after the <i>Safety On</i> timer has expired.
	Low Fuel Level	The module detects that the fuel level is below the configured setting
	Over Frequency Warning	The generator output frequency has risen above the pre-set pre-alarm setting.
	Over Speed Warning	The engine speed has risen above the overspeed pre alarm setting
	Under Frequency Warning	The generator output frequency has fallen below the pre-set pre-alarm setting after the <i>Safety On</i> timer has expired.
	Under Speed Warning	The engine speed has fallen below the underspeed pre alarm setting
	Flexible Sensor	The flexible sensor warning alarm has been triggered.

## 7.5 SHUTDOWN ALARMS





Shutdowns are latching alarms and stop the Generator. Clear the alarm and remove the fault then press Stop/Reset  to reset the module.

 **NOTE:-** The alarm condition must be rectified before a reset will take place. If the alarm condition remains, it will not be possible to reset the unit (The exception to this is the Low Oil Pressure alarm and similar 'delayed alarms', as the oil pressure will be low with the engine at rest).

Display	Reason
 CAN CAN ECU Data Fail	The module is configured for CAN operation and does not detect data on the engine Can datalink, the engine shuts down.
 ECM CAN ECU Shutdown	The engine ECU has detected a shutdown alarm and has informed the DSE module of this situation. The exact error is also indicated on the module's display.
 A-D Digital Input A-D	Auxiliary Digital inputs can be user configured as Digital inputs and will display the relevant icon.
 A-C Analogue Input A-C	Auxiliary Analogue inputs can be user configured as Digital inputs and will display the relevant icon.
 Emergency Stop	The emergency stop button has been depressed. This is a failsafe (normally closed to battery negative) input and will immediately stop the set should the signal be removed.
 <b>NOTE:-</b> The Emergency Stop Negative signal must be present otherwise the unit will shutdown.	
 Fail To Start	The engine has not fired after the preset number of start attempts
 Generator High Voltage Shutdown	The generator output voltage has risen above the preset level
 Generator Low Voltage Shutdown	The generator output voltage has fallen below the preset level
 High Coolant Temperature Shutdown	The module detects that the engine coolant temperature has exceeded the high engine temperature shutdown setting after the <i>Safety On</i> timer has expired.
 Loss of Mag. Pickup Signal	The speed signal from the magnetic pickup is not being received by the DSE controller.
 Low Oil Pressure Shutdown	The engine oil pressure has fallen below the low oil pressure trip setting level after the <i>Safety On</i> timer has expired.
 Low Fuel Level	The module detects that the fuel level is below the configured setting
 Over Frequency Shutdown	The generator output frequency has risen above the preset level
 Over Speed Shutdown	The engine speed has exceeded the pre-set trip
 Under Frequency Shutdown	The generator output frequency has fallen below the preset level
 Under Speed Shutdown	The engine speed has fallen below the pre-set trip after the <i>Safety On</i> timer has expired.

Continued overleaf



Continued...

<b>Display</b>		<b>Reason</b>
	Temperature sensor open circuit	Temperature sensor has been detected as being open circuit.
	Oil pressure sensor open circuit	Oil pressure sensor has been detected as being open circuit.
	Flexible Sensor	The flexible sensor shutdown alarm has been triggered.
	Magnetic pickup open circuit	Magnetic pickup sensor has been detected as being open circuit.

## 7.6 ELECTRICAL TRIP ALARMS

Electrical trips are latching and stop the Generator but in a controlled manner. On initiation of the electrical trip condition the module will de-energise the '**Close Generator**' Output to remove the load from the generator. Once this has occurred the module will start the Cooling timer and allow the engine to cool off-load before shutting down the engine. The alarm must be accepted and cleared, and the fault removed to reset the module.

Electrical trips are latching alarms and stop the Generator. Remove the fault then press Stop/Reset  to reset the module.

	Digital Input A-D	Auxiliary Digital inputs can be user configured as Digital inputs and will display the relevant icon.
	Analogue Input A-C	Auxiliary Analogue inputs can be user configured as Digital inputs and will display the relevant icon.



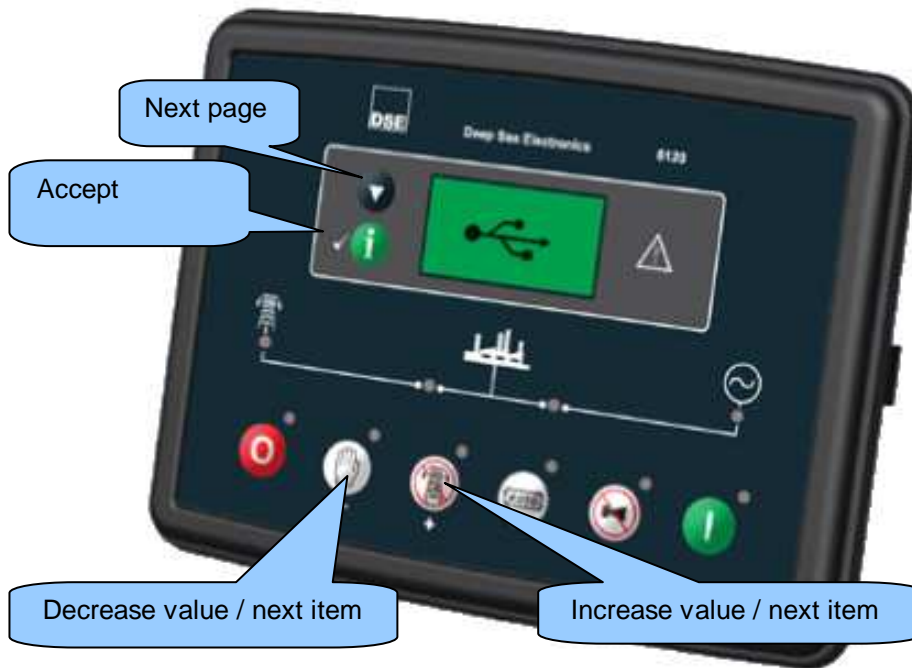

## 8 FRONT PANEL CONFIGURATION

This configuration mode allows the operator limited customising of the way the module operates. All available parameters can be adjusted by this method, or alternatively by using the optional DSE Configuration Suite Software for Windows PC in conjunction with a USB A-B cable. Full details of this are contained in the 60xx Configuration Suite Software Manual.

Use the module's navigation buttons to traverse the menu and make value changes to the parameters:





### 8.1 ACCESSING THE FRONT PANEL EDITOR (FPE)



- Ensure the engine is at rest and the module is in STOP mode by pressing the Stop/Reset  button.
- Simultaneously press the Stop/Reset  and Accept  buttons.
- The configuration icon  is displayed, along with the first configurable parameter.

### 8.2 EDITING A PARAMETER



Press  to select the required 'page' as detailed in the configuration tables.

Press  (+) to select the next parameter or  (-) to select the previous parameter within the current page.

When viewing the parameter to be changed, press the  button. The value begins to flash.







Press  (+) or  (-) to adjust the value to the required setting.





Press  to save the current value, the value ceases flashing.

Press and hold the  button to exit the editor, the configuration icon  will be removed from the display.

**NOTE:** - When the editor is visible, it automatically closes after 5 minutes of inactivity to ensure security.

















### 8.3 ADJUSTABLE PARAMETERS

CONFIGURATION PARAMETERS – MODULE (Page 1)				6010		6020	
				MPU	CAN	MPU	CAN
101		Contrast	000 (%)	✓	✓	✓	✓
102		Fast loading enable	On (1), Off (0)	✓	✓	✓	✓
103		RESERVED					
104		Lamp test at startup	On (1), Off (0)	✓	✓	✓	✓
105		Power save mode enable	On (1), Off (0)	✓	✓	✓	✓
106		RESERVED					
107		RESERVED					
108		Event log display format	On (1), Off (0)	✓	✓	✓	✓
109		Module powers up into AUTO mode	On (1), Off (0)	✓	✓	✓	✓
110		DTC string (English only) enable	On (1), Off (0)	X	✓	X	✓













CONFIGURATION PARAMETERS – APPLICATION (Page 2)				6010		6020	
				MPU	CAN	MPU	CAN
201		Alternate Engine Speed	On (1), Off (0)	X	✓	X	✓
202		CAN ECU data fail enable	On (1), Off (0)	X	✓	X	✓
203		CAN ECU data fail action	0 (Action)	X	✓	X	✓
204		CAN ECU data fail delay	0:00	X	✓	X	✓



















CONFIGURATION PARAMETERS – INPUTS (Page 3)				6010		6020	
				MPU	CAN	MPU	CAN
301		Low oil pressure enable	On (1), Off (0)	✓	✓	✓	✓
302		Low oil pressure trip	0 PSI 0.00 bar 0 kPa	✓	✓	✓	✓
303		High engine temperature trip	00 deg C	✓	✓	✓	✓
304		Digital input A source	0 (Input source)	✓	✓	✓	✓
305		Digital input A polarity	0 (Polarity)	✓	✓	✓	✓
306		Digital input A action (if source = user config)	0 (Action)	✓	✓	✓	✓
307		Digital input A arming (if source = user config)	0 (Arming)	✓	✓	✓	✓
308		Digital input A activation delay (if source = user config)	0:00	✓	✓	✓	✓
309		Digital input B source	0 (Input source)	✓	✓	✓	✓
310		Digital input B polarity	0 (Polarity)	✓	✓	✓	✓
311		Digital input B action (if source = user config)	0 (Action)	✓	✓	✓	✓
312		Digital input B arming (if source = user config)	0 (Arming)	✓	✓	✓	✓
313		Digital input B activation delay (if source = user config)	0:00	✓	✓	✓	✓
314		Digital input C source	0 (Input source)	✓	✓	✓	✓
315		Digital input C polarity	0 (Polarity)	✓	✓	✓	✓
316		Digital input C action (if source = user config)	0 (Action)	✓	✓	✓	✓
317		Digital input C arming (if source = user config)	0 (Arming)	✓	✓	✓	✓
318		Digital input C activation delay (if source = user config)	0:00	✓	✓	✓	✓
319		Digital input D source	0 (Input source)	✓	✓	✓	✓
320		Digital input D polarity	0 (Polarity)	✓	✓	✓	✓
321		Digital input D action (if source = user config)	0 (Action)	✓	✓	✓	✓
322		Digital input D arming (if source = user config)	0 (Arming)	✓	✓	✓	✓
323		Digital input D activation delay (if source = user config)	0:00	✓	✓	✓	✓
324		Analogue input A sensor type	0 (sensor type)	✓	✓	✓	✓
325		Analogue input A sensor selection (temperature sensor list)	0 (pressure sensor)	✓	✓	✓	✓
326		Analogue input A (set as digital) source (oil pressure sender)	0 (Input source)	✓	✓	✓	✓
327		Analogue input A (set as digital) polarity	0 (Polarity)	✓	✓	✓	✓
328		Analogue input A (set as digital) action (if source = user config)	0 (Action)	✓	✓	✓	✓
329		Analogue input A (set as digital) arming (if source = user config)	0 (Arming)	✓	✓	✓	✓
330		Analogue input A (set as digital) activation delay (if source = user config)	0:00	✓	✓	✓	✓





































CONFIGURATION PARAMETERS – INPUTS (Page 3) continued				6010		6020	
				MPU	CAN	MPU	CAN
331		Analogue input B sensor type	0 (sensor type)	✓	✓	✓	✓
332		Analogue input B sensor selection (temperature sensor list)	0 (temp sensor)	✓	✓	✓	✓
333		Analogue input B (set as digital) source (temperature sender)	0 (Input source)	✓	✓	✓	✓
334		Analogue input B polarity	0 (Polarity)	✓	✓	✓	✓
335		Analogue input B (set as digital) action (if source = user config)	0 (Action)	✓	✓	✓	✓
336		Analogue input B (set as digital) arming (if source = user config)	0 (Arming)	✓	✓	✓	✓
337		Analogue input B (set as digital) activation delay (if source = user config)	0:00	✓	✓	✓	✓
338		Analogue input C sensor type	0 (sensor type)	✓	✓	✓	✓
339		Analogue input C sensor selection (temperature sensor list)	0 (pressure, temperature or percentage sensor)	✓	✓	✓	✓
340		Analogue input C (set as digital) source (flexible sender)	0 (Input source)	✓	✓	✓	✓
341		Analogue input C (set as digital) polarity	0 (Polarity)	✓	✓	✓	✓
342		Analogue input C (set as digital) action (if source = user config)	0 (Action)	✓	✓	✓	✓
343		Analogue input C (set as digital) arming (if source = user config)	0 (Arming)	✓	✓	✓	✓
344		Analogue input C (set as digital) activation delay (if source = user config)	0:00	✓	✓	✓	✓
345		Oil pressure sender open circuit alarm enable	On (1), Off (0)	✓	✓	✓	✓
346		Temperature sender open circuit alarm enable	On (1), Off (0)	✓	✓	✓	✓

Continued overleaf...

CONFIGURATION PARAMETERS – OUTPUTS (Page 4)				6010		6020	
				MPU	CAN	MPU	CAN
401		Digital output A source	0 (Output source)	X	✓	X	✓
402		Digital output A polarity	0 (Output source Polarity)	X	✓	X	✓
403		Digital output B source	0 (Output source)	X	✓	X	✓
404		Digital output B polarity	0 (Output source Polarity)	X	✓	X	✓
405		Digital output C source	0 (Output source)	✓	✓	✓	✓
406		Digital output C polarity	0 (Output source Polarity)	✓	✓	✓	✓
407		Digital output D source	0 (Output source)	✓	✓	✓	✓
408		Digital output D polarity	0 (Output source Polarity)	✓	✓	✓	✓
409		Digital output E source	0 (Output source)	✓	✓	✓	✓
410		Digital output E polarity	0 (Output source Polarity)	✓	✓	✓	✓
411		Digital output F source	0 (Output source)	✓	✓	✓	✓
412		Digital output F polarity	0 (Output source Polarity)	✓	✓	✓	✓

































CONFIGURATION PARAMETERS – TIMERS (Page 5)				6010		6020	
				MPU	CAN	MPU	CAN
501		Mains transient delay	0 s	X	X	✓	✓
502		Start Delay	0:00	✓	✓	✓	✓
503		Preheat	0:00	✓	✓	✓	✓
504		Cranking	0 s	✓	✓	✓	✓
505		Crank rest time	0 s	✓	✓	✓	✓
506		Smoke limiting	0:00	✓	✓	✓	✓
507		Smoke limiting off	0 s	✓	✓	✓	✓
508		Safety On Delay	0 s	✓	✓	✓	✓
509		Warming up time	0:00	✓	✓	✓	✓
510		Return Delay	0:00	✓	✓	✓	✓
511		Cooling Time	0:00	✓	✓	✓	✓
512		ETS Solenoid Hold	0:00	✓	✓	✓	✓
513		Failed to stop delay	0:00	✓	✓	✓	✓
514		Generator transient delay	0.0 s	✓	✓	✓	✓
515		Power save mode delay	0:00	✓	✓	✓	✓
516		Transfer time	0.0 s	X	X	✓	✓
517		Breaker trip pulse	0.0 s	✓	✓	✓	✓
518		Breaker close pulse	0.0 s	✓	✓	✓	✓

CONFIGURATION PARAMETERS – GENERATOR (Page 6)				6010		6020	
				MPU	CAN	MPU	CAN
601		Alternator Fitted	On (1), Off (0)	✓	✓	✓	✓
602		Alternator Poles	0	✓	✓	✓	✓
603		RESERVED					
604		RESERVED					
605		Under Voltage shutdown enabled	On (1), Off (0)	✓	✓	✓	✓
606		Under Voltage shutdown level	0 V	✓	✓	✓	✓
607		Loading Voltage	0 V	✓	✓	✓	✓
608		Over Voltage shutdown level	0 V	✓	✓	✓	✓
609		Under frequency shutdown enable	On (1), Off (0)	✓	✓	✓	✓
610		Under frequency shutdown level	0.0 Hz	✓	✓	✓	✓
611		Loading Frequency	0.0 Hz	✓	✓	✓	✓
612		Nominal Frequency	0.0 Hz	✓	✓	✓	✓
613		Over frequency shutdown enable	On (1), Off (0)	✓	✓	✓	✓
614		Over Frequency shutdown level	0.0 Hz	✓	✓	✓	✓
615		AC System	0 (AC system)	✓	✓	✓	✓
616		CT Primary	0 (Amps)	✓	✓	✓	✓
617		Full load rating	0 (Amps)	✓	✓	✓	✓
618		Immediate Over current	On (1), Off (0)	✓	✓	✓	✓
619		Over current Delayed Alarm	On (1), Off (0)	✓	✓	✓	✓
620		Over current Delayed Alarm Action	0 (Action)	✓	✓	✓	✓
621		Over current Delay	0:00:00	✓	✓	✓	✓
622		Over current Trip	0 (%)	✓	✓	✓	✓







CONFIGURATION PARAMETERS – MAINS (Page 7)				6010		6020	
				MPU	CAN	MPU	CAN
701		AC system	0 (AC system)	X	X	✓	✓
702		Mains failure detection	On (1), Off (0)	X	X	✓	✓
703		Immediate mains dropout	On (1), Off (0)	X	X	✓	✓
704		Mains under voltage enable	On (1), Off (0)	X	X	✓	✓
705		Mains under voltage trip level	0 V 00	X	X	✓	✓
706		Mains under voltage return	0 V	X	X	✓	✓
707		Mains over voltage enable	On (1), Off (0)	X	X	✓	✓
708		Mains over voltage return	0 V	X	X	✓	✓
709		Mains over Voltage trip level	0 V	X	X	✓	✓
710		Mains under frequency trip enable	On (1), Off (0)	X	X	✓	✓
711		Mains under frequency trip level	0.0 Hz	X	X	✓	✓
712		Mains under frequency return	0.0 Hz	X	X	✓	✓
713		Mains over frequency trip enable	On (1), Off (0)	X	X	✓	✓
714		Mains over frequency return	0 Hz	X	X	✓	✓
715		Mains over frequency trip level	0.0 Hz	X	X	✓	✓









**Generator and Mains AC System**

0	2 Phase 3 wire (L1-L2)
1	2 Phase 3 wire (L2-L3)
2	3 Phase 3 wire
3	3 Phase 4 wire
4	3 Phase 4 wire delta
5	Single Phase 2 wire

CONFIGURATION PARAMETERS – ENGINE (Page 8)				6010		6020	
				MPU	CAN	MPU	CAN
801		Magnetic pickup fitted	On (1), Off (0)	✓	X	✓	X
802		Flywheel teeth	000	✓	X	✓	X
803		Start Attempts	0	✓	✓	✓	✓
804		RESERVED					
805		RESERVED					
806		Gas choke timer (Gas engine only)	0:00	✓	X	✓	X
807		Gas on delay (Gas engine only)	0:00	✓	X	✓	X
808		Gas ignition off delay (Gas engine only)	0:00	✓	X	✓	X
809		Crank disconnect on Oil pressure enable	On (1), Off (0)	✓	✓	✓	✓
810		Check oil pressure prior to starting	On (1), Off (0)	✓	✓	✓	✓
811		Crank disconnect on Oil pressure	0.00 Bar	✓	✓	✓	✓
812		Crank disconnect on frequency	0.0Hz	✓	✓	✓	✓
813		Crank disconnect on Engine Speed	000 rpm	✓	✓	✓	✓
814		Under speed enable	On (1), Off (0)	✓	✓	✓	✓
815		Under speed shutdown	0000 rpm	✓	✓	✓	✓
816		Over speed shutdown	0000 rpm	✓	✓	✓	✓
817		Low battery volts enable	On (1), Off (0)	✓	✓	✓	✓
818		Low battery volts warning	00.0 V	✓	✓	✓	✓
819		Low battery volts return	00.0 V	✓	✓	✓	✓
820		Low battery volts delay	0:00:00	✓	✓	✓	✓
821		High battery volts enable	On (1), Off (0)	✓	✓	✓	✓
822		High battery volts return	00.0 V	✓	✓	✓	✓
823		High battery volts trip	00.0 V	✓	✓	✓	✓
824		High battery volts delay	0:00:00	✓	✓	✓	✓
825		Charge alt shutdown enable	On (1), Off (0)	✓	✓	✓	✓
826		Charge alt shutdown trip	00.0 V	✓	✓	✓	✓
827		Charge alt shutdown delay	0:00:00	✓	✓	✓	✓
828		Charge alt warning enable	On (1), Off (0)	✓	✓	✓	✓
829		Charge alt warning trip	00.0 V	✓	✓	✓	✓
830		Charge alt warning delay	0:00:00	✓	✓	✓	✓
831		Low battery start arming	On (1), Off (0)	✓	✓	✓	✓
832		Low battery start threshold	00.0 V	✓	✓	✓	✓
833		Low battery start delay	0:00:00	✓	✓	✓	✓
834		Low battery start run time	0:00:00	✓	✓	✓	✓

CONFIGURATION PARAMETERS – ALT' CONFIGURATION (PAGE 9)				6010		6020	
				MPU	CAN	MPU	CAN
901		Default configuration	On (1), Off (0)	✓	✓	✓	✓
902		Alt config - Enable configuration	On (1), Off (0)	✓	✓	✓	✓
903		Alt config - Alternative Engine Speed	On (1), Off (0)	X	✓	X	✓
904		Alt config - Under Voltage Shutdown enable	On (1), Off (0)	✓	✓	✓	✓
905		Alt config - Under Voltage Shutdown trip	0 V	✓	✓	✓	✓
906		Alt config - Loading Voltage	0 V	✓	✓	✓	✓
907		Alt config - Over Voltage trip	0 V	✓	✓	✓	✓
908		Alt config - Under frequency shutdown enable	On (1), Off (0)	✓	✓	✓	✓
909		Alt config - Under frequency shutdown trip	0.0 Hz	✓	✓	✓	✓
910		Alt config - Loading Frequency	0.0 Hz	✓	✓	✓	✓
911		Alt config - Nominal Frequency	0.0 Hz	✓	✓	✓	✓
912		Alt config - Over Frequency shutdown enable	On (1), Off (0)	✓	✓	✓	✓
913		Alt config - Over Frequency shutdown trip	0.0 Hz	✓	✓	✓	✓
914		Alt config - CT Primary	0 (Amps)	✓	✓	✓	✓
915		Alt config - Full load rating	0 (Amps)	✓	✓	✓	✓
916		Alt config - Immediate Over current	On (1), Off (0)	✓	✓	✓	✓
917		Alt config - Over current Delayed Alarm	On (1), Off (0)	✓	✓	✓	✓
918		Alt config - Over current Delayed Alarm Action	0 (Action)	✓	✓	✓	✓
919		Alt config - Over current Delay	0:00:00	✓	✓	✓	✓
920		Alt config - Over current Trip	0 (%)	✓	✓	✓	✓
921		Alt config - AC system	0 (AC system)	X	X	✓	✓
922		Alt config - Mains failure detection	On (1), Off (0)	X	X	✓	✓
923		Alt config - Immediate mains dropout	On (1), Off (0)	X	X	✓	✓
924		Alt config - Mains under volt enable	On (1), Off (0)	X	X	✓	✓
925		Alt config - Mains under volt trip	0 V	X	X	✓	✓
926		Alt config - Mains under volt return	0 V	X	X	✓	✓
927		Alt config - Mains over volt enable	On (1), Off (0)	X	X	✓	✓
928		Alt config - Mains over volt return	0 V	X	X	✓	✓
929		Alt config - Mains over volt trip	0 V	X	X	✓	✓
930		Alt config - Mains under frequency enable	On (1), Off (0)	X	X	✓	✓
931		Alt config - Mains under frequency trip	0.0 Hz	X	X	✓	✓
932		Alt config - Mains under frequency return	0.0 Hz	X	X	✓	✓

933		Alt config - Mains over frequency enable	On (1), Off (0)	X	X	✓	✓
934		Alt config - Mains over frequency return	0.0 Hz	X	X	✓	✓
935		Alt config - Mains over frequency trip	0.0 Hz	X	X	✓	✓
936		Alt config - Alternative Under speed shutdown enable	On (1), Off (0)	✓	✓	✓	✓
937		Alt config - Alternative Under speed shutdown trip	0000 rpm	✓	✓	✓	✓
938		Alt config - Alternative Over speed shutdown trip	0000 rpm	✓	✓	✓	✓

CONFIGURATION PARAMETERS – FLEXIBLE SENSOR (PAGE 10)				6010		6020	
				MPU	CAN	MPU	CAN
1001		Flexible sensor alarm arming	0 (Arming)	✓	✓	✓	✓
1002		Flexible sensor - Low alarm enable	0 (Arming)	✓	✓	✓	✓
1003		Flexible sensor - Low alarm trip (units depend upon sensor type)	0 % 0.00 bar 0 °C	✓	✓	✓	✓
1004		Flexible sensor - High alarm enable	0 % 0.00 bar 0 °C	✓	✓	✓	✓
1005		Flexible sensor - High alarm trip (units depend upon sensor type)	0 (Action)	✓	✓	✓	✓
1006		Flexible sensor - Low warning enable	0 % 0.00 bar 0 °C	✓	✓	✓	✓
1007		Flexible sensor - Low warning trip (units depend upon sensor type)	On (1), Off (0)	✓	✓	✓	✓
1008		Flexible sensor – High warning enable	0 % 0.00 bar 0 °C	✓	✓	✓	✓
1009		Flexible sensor – High warning trip (units depend upon sensor type)	On (1), Off (0)	✓	✓	✓	✓

Flexible sensor type selection	
0	None
1	Digital input
2	Percentage sensor
3	Pressure sensor
4	Temperature sensor

CONFIGURATION PARAMETERS – SCHEDULER (PAGE 11)			6010		6020	
			MPU	CAN	MPU	CAN
1101	Enable scheduler	On (1), Off (0)	✓	✓	✓	✓
1102	On or off load	On (1), Off (0)	✓	✓	✓	✓
1103	Start time	0:00:00	✓	✓	✓	✓
1104	Day	0 (Day, 0=Monday)	✓	✓	✓	✓
1105	Duration	0:00:00	✓	✓	✓	✓

CONFIGURATION PARAMETERS – TIME (PAGE 12)			6010		6020	
			MPU	CAN	MPU	CAN
1201	Time of day	0:00	✓	✓	✓	✓
1202	Day of week	0 (Day, 0=Monday)	✓	✓	✓	✓

Parameters with multiple choices use the following identification tables for the parameter values.

INPUT SOURCE LIST		6010	6020
0	User Configured	✓	✓
1	Alarm Mute	✓	✓
2	Alarm Reset	✓	✓
3	Alternative Configuration	✓	✓
4	Auto restore inhibit	X	✓
5	Auto start inhibit	✓	✓
6	Auxiliary mains fail	X	✓
7	Coolant Temperature Switch	✓	✓
8	Emergency Stop	✓	✓
9	External Panel Lock	✓	✓
10	RESERVED		
11	Generator load inhibit	✓	✓
12	Lamp Test	✓	✓
13	Low Fuel Level Switch	✓	✓
14	RESERVED		
15	Mains load inhibit	X	✓
16	Oil Pressure Switch	✓	✓
17	Remote Start Off Load	✓	✓
18	Remote Start On Load	✓	✓
19	Simulate mains available	X	✓
20	Smoke Limiting	✓	✓
21	Transfer to Generator/Open Mains (6020) Close Generator (6010)	✓	✓
22	Transfer to Mains/Open Generator (6020) Open Generator (6010)	✓	✓

INPUT ACTION LIST	
Index	Action
0	Electrical Trip
1	Shutdown
2	Warning

INPUT ARMING LIST	
Index	Arming
0	Always
1	From Safety On
2	From Starting
3	Never

INPUT POLARITY LIST	
Index	Action
0	Close to Activate
1	Open to Activate

OUTPUT POLARITY LIST	
Index	Arming
0	Energise
1	De-energise

CAN DATA FAIL ACTION	
Index	Action
0	None
1	Shutdown
2	Warning always latched

CAN DATA FAIL ARMING	
Index	Arming
0	From Safety On
1	From Starting

Oil pressure Sensor selection	
0	Not used
1	Digital closed for alarm
2	Digital open for alarm
3	VDO 5 Bar
4	VDO 10 Bar
5	Datacon 5 Bar
6	Datacon 10 Bar
7	Datacon 7 Bar
8	Murphy 7 Bar
9	CMB812
10	Veglia
11	User defined



Coolant temperature sensor selection	
0	Not used
1	Digital closed for alarm
2	Digital open for alarm
3	VDO 120 °C
4	Datacon high
5	Datacon low
6	Murphy
7	Cummins
8	PT100
9	Veglia
10	Beru
11	User defined

Flexible sensor selections for Percentage type	
0	Not used
1	Digital closed for alarm
2	Digital open for alarm
3	VDO Ohm range (10-180)
4	VDO Tube (90-0)
5	US Ohm range (240-33)
6	GM Ohm range (0-90)
7	GM Ohm range (0-30)
8	Ford (73-10)
9	User defined

OUTPUT SOURCE LIST		6010		6020	
		MPU	CAN	MPU	CAN
0	Not Used	✓	✓	✓	✓
1	RESERVED	X	X	X	X
2	RESERVED	X	X	X	X
3	Audible Alarm	✓	✓	✓	✓
4	Battery Over Volts Warning	✓	✓	✓	✓
5	Battery Under Volts Warning	✓	✓	✓	✓
6	CAN ECU Data Fail	X	✓	X	✓
7	CAN ECU Error	X	✓	X	✓
8	CAN ECU Fail	X	✓	X	✓
9	CAN ECU Power	X	✓	X	✓
10	CAN ECU Stop	X	✓	X	✓
11	Charge Alternator Shutdown	✓	✓	✓	✓
12	Charge Alternator Warning	✓	✓	✓	✓
13	Close Gen Output	✓	✓	✓	✓
14	Close Gen Output Pulse	✓	✓	✓	✓
15	Close Mains Output	X	X	✓	✓
16	Close Mains Output Pulse	X	X	✓	✓
17	Combined Mains Failure	X	X	✓	✓
18	Common Alarm	✓	✓	✓	✓
19	Common Electrical Trip	✓	✓	✓	✓
20	Common Shutdown	✓	✓	✓	✓
21	Common Warning	✓	✓	✓	✓
22	RESERVED	X	X	X	X
23	RESERVED	X	X	X	X
24	RESERVED	X	X	X	X
25	RESERVED	X	X	X	X
26	RESERVED	X	X	X	X
27	RESERVED	X	X	X	X
28	RESERVED	X	X	X	X
29	Emergency Stop	✓	✓	✓	✓
30	Energise To Stop	✓	✓	✓	✓
31	RESERVED	X	X	X	X
32	Fail To Start	✓	✓	✓	✓
33	Fuel Relay	✓	✓	✓	✓
34	Gas Choke On	✓	X	✓	X
35	Gas Ignition	✓	X	✓	X
36	Generator Available	✓	✓	✓	✓
37	Generator Over Voltage Shutdown	✓	✓	✓	✓
38	Generator Under Voltage Shutdown	✓	✓	✓	✓
39	RESERVED	X	X	X	X
40	RESERVED	X	X	X	X
41	Low Fuel Level	✓	✓	✓	✓
42	Low Oil Pressure (Shutdown)	✓	✓	✓	✓
43	RESERVED	X	X	X	X
44	RESERVED	X	X	X	X
45	RESERVED	X	X	X	X
46	RESERVED	X	X	X	X
47	Open Gen Output	✓	✓	✓	✓
48	Open Gen Output Pulse	✓	✓	✓	✓
49	Open Mains Output	X	X	✓	✓
50	Open Mains Output Pulse	X	X	✓	✓
51	RESERVED	X	X	X	X
52	RESERVED	X	X	X	X
53	Preheat During Preheat Timer	✓	✓	✓	✓
54	Preheat Until End Of Crank	✓	✓	✓	✓
55	Preheat Until End Of Safety Timer	✓	✓	✓	✓
56	Preheat Until End Of Warming Timer	✓	✓	✓	✓
57	Smoke Limiting	✓	✓	✓	✓
58	Start Relay	✓	✓	✓	✓
59	RESERVED	X	X	X	X
60	RESERVED	X	X	X	X
61	Waiting For Manual Restore	X	X	✓	✓
62	Flexible Sender High Shutdown	✓	✓	✓	✓
63	Flexible Sender High Warning	✓	✓	✓	✓
64	Flexible Sender Low Warning	✓	✓	✓	✓
65	Flexible Sender Low Shutdown	✓	✓	✓	✓



## 9 COMMISSIONING

### 9.1.1 PRE-COMMISSIONING

Before the system is started, it is recommended that the following checks are made:-

- The unit is adequately cooled and all the wiring to the module is of a standard and rating compatible with the system. Check all mechanical parts are fitted correctly and that all electrical connections (including earths) are sound.
- The unit **DC** supply is fused and connected to the battery and that it is of the correct polarity.
- The Emergency Stop input is wired to an external normally closed switch connected to **DC** positive.

 **NOTE:- If Emergency Stop feature is not required, link this input to the DC Negative. The module will not operate unless either the Emergency Stop is fitted correctly OR terminal 3 is connected to DC Positive.**

- To check the start cycle operation, take appropriate measures to prevent the engine from starting (disable the operation of the fuel solenoid). After a visual inspection to ensure it is safe to proceed, connect the battery supply. Select **“MANUAL”** and then press **“START”** the unit start sequence will commence.
- The starter will engage and operate for the pre-set crank period. After the starter motor has attempted to start the engine for the pre-set number of attempts, the LCD will display *‘Failed to start’*. Select the **STOP/RESET** position to reset the unit.
- Restore the engine to operational status (reconnect the fuel solenoid). Select **“MANUAL”** and then press **“START”**. This time the engine should start and the starter motor should disengage automatically. If not then check that the engine is fully operational (fuel available, etc.) and that the fuel solenoid is operating. The engine should now run up to operating speed. If not, and an alarm is present, check the alarm condition for validity, then check input wiring. The engine should continue to run for an indefinite period. It will be possible at this time to view the engine and alternator parameters - refer to the ‘Description of Controls’ section of this manual.
- Select **“AUTO”** on the front panel, the engine will run for the pre-set cooling down period, then stop. The generator should stay in the standby mode. If not, check that there is no signal present on the **Remote start** input.
- Initiate an automatic start by supplying the remote start signal (if configured). The start sequence will commence and the engine will run up to operational speed. Once the generator is available a load transfer will take place (if configured), the Generator will accept the load. If not, check the wiring to the Generator Contactor Coil (*if used*). Check the Warming timer has timed out.
- Remove the remote start signal. The return sequence will begin. After the pre-set time, the generator is unloaded. The generator will then run for the pre-set cooling down period, then shutdown into its standby mode.
- Set the module internal clock/calendar to ensure correct operation of the scheduler and event logging functions. For details of this procedure see section entitled *Front Panel Configuration – Editing the date and time*.
- If, despite repeated checking of the connections between the **60xx** series controller and the customer’s system, satisfactory operation cannot be achieved, then the customer is requested to contact the factory for further advice on:-

**INTERNATIONAL TEL: +44 (0) 1723 890099**

**INTERNATIONAL FAX: +44 (0) 1723 893303**

**E-mail: [Support@Deepseapl.com](mailto:Support@Deepseapl.com)**

**Website : [www.deepseapl.com](http://www.deepseapl.com)**

## 10 FAULT FINDING

SYMPTOM	POSSIBLE REMEDY
Unit is inoperative Read/Write configuration does not operate	Check the battery and wiring to the unit. Check the DC supply. Check the DC fuse.
Unit shuts down	Check DC supply voltage is not above 35 Volts or below 9 Volts Check the operating temperature is not above 70°C. Check the DC fuse.
Unit locks out on Emergency Stop	If no Emergency Stop Switch is fitted, ensure that a DC positive signal is connected to the Emergency Stop input. Check emergency stop switch is functioning correctly. Check Wiring is not open circuit.
Intermittent Magnetic Pick-up sensor fault	Ensure that Magnetic pick-up screen only connects to earth at one end, if connected at both ends, this enables the screen to act as an aerial and will pick up random voltages. Check pickup is correct distance from the flywheel teeth.
Low oil Pressure fault operates after engine has fired	Check engine oil pressure. Check oil pressure switch/sensor and wiring. Check configured polarity (if applicable) is correct (i.e. Normally Open or Normally Closed) or that sensor is compatible with the 60xx Module and is correctly configured.
High engine temperature fault operates after engine has fired.	Check engine temperature. Check switch/sensor and wiring. Check configured polarity (if applicable) is correct (i.e. Normally Open or Normally Closed) or that sensor is compatible with the 60xx series module.
Shutdown fault operates	Check relevant switch and wiring of fault indicated on LCD display. Check configuration of input.
Warning fault operates	Check relevant switch and wiring of fault indicated on LCD display. Check configuration of input.
Fail to Start is activated after pre-set number of attempts to start	Check wiring of fuel solenoid. Check fuel. Check battery supply. Check battery supply is present on the Fuel output of the module. Check the speed-sensing signal is present on the 60xx series module inputs. Refer to engine manual.
Continuous starting of generator when in <b>AUTO</b>	Check that there is no signal present on the "Remote Start" input. Check configured polarity is correct.
Generator fails to start on receipt of Remote Start signal.	Check Start Delay timer has timed out.  Check signal is on "Remote Start" input. Confirm correct configuration of input is configured to be used as "Remote Start".  Check that the oil pressure switch or sensor is indicating low oil pressure to the controller. Depending upon configuration, the set will not start if oil pressure is not low.
Pre-heat inoperative	Check wiring to engine heater plugs. Check battery supply. Check battery supply is present on the Pre-heat output of module. Check pre-heat configuration is correct.
Starter motor inoperative	Check wiring to starter solenoid. Check battery supply. Check battery supply is present on the Starter output of module. Ensure that the Emergency Stop input is at Positive. Ensure oil pressure switch or sensor is indicating the "low oil pressure" state to the 60xx series controller.
Engine runs but generator will not take load	Check Warm up timer has timed out. Ensure generator load inhibit signal is not present on the module inputs. Check connections to the switching device. Note that the set will not take load in manual mode unless there is an active remote start on load signal.

SYMPTOM	POSSIBLE REMEDY
<p>Incorrect reading on Engine gauges</p> <p>Fail to stop alarm when engine is at rest</p>	<p>Check engine is operating correctly. Check sensor and wiring.</p>
<p>Module appears to 'revert' to an earlier configuration</p>	<p>When editing a configuration using the PC software it is vital that the configuration is first 'read' from the controller before editing it. This edited configuration must then be "written" back to the controller for the changes to take effect.</p> <p>When editing a configuration using the Front Panel Editor, be sure to press the Save  button to save the change before moving to another item or exiting the Front Panel Editor.</p>
<p>Set will not take load</p>	<p>Ensure the generator is available.</p> <p>Check that the output configuration is correct to drive the load switch device and that all connections are correct.</p> <p>Remember that the set will not take load in manual mode unless a remote start on load input is present.</p>
<p>Inaccurate generator measurements on controller display</p>	<p>The 60xx series controller is true RMS measuring so gives more accurate display when compared with an 'average' meter such as an analogue panel meter or some lower specified digital multimeters.</p> <p>Accuracy of the controller is better than 1% of full scale. Ie Gen volts full scale is 333V ph-n so accuracy is <math>\pm 3.33V</math> (1% of 333V).</p>

 **NOTE:- The above fault finding is provided as a guide check-list only. As the module can be configured to provide a wide range of different features, always refer to the source of your module configuration if in doubt.**

## 11 MAINTENANCE, SPARES, REPAIR AND SERVICING







The DSE60xx Series controller is designed to be *Fit and Forget*. As such, there are no user serviceable parts within the controller.

In the case of malfunction, you should contact your original equipment supplier (OEM).

### 11.1 PURCHASING ADDITIONAL CONNECTOR PLUGS FROM DSE







If you require additional plugs from DSE, please contact our Sales department using the part numbers below.

#### 11.1.1 DSE6010

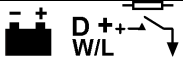
6010 terminal designation	Plug description	Part No.
1-11 	11 way 5.08mm	007-451
12-15 	4 way 5.08mm	007-444
16-18 	3 way 5.08mm	007-174
19-22 	4 way 7.62mm	007-171
27-31 	5 way 5.08mm	007-445
32-35 	4 way 5.08mm	007-444

 **NOTE:-** Terminals 22-26 and 36-37 are not fitted to DSE6010 controller.

#### 11.1.2 DSE6020

6020 terminal designation	Plug description	Part No.
1-11 	11 way 5.08mm	007-451
12-15 	4 way 5.08mm	007-444
16-18 	3 way 5.08mm	007-174
19-26 	8 way 7.62mm	007-171
27-31 	5 way 5.08mm	007-445
32-35 	4 way 5.08mm	007-444

 **NOTE:-** Terminals 36-37 are not fitted to DSE6010 controller.

### 11.2 PURCHASING ADDITIONAL FIXING CLIPS FROM DSE

Item	Description	Part No.
	60xx series fixing clips (packet of 4)	020-294

### 11.3 PURCHASING SEALING GASKET FROM DSE

The optional sealing gasket is not supplied with the controller but can be purchased separately.

Item	Description	Part No.
	60xx series silicon sealing gasket	020-313



## 12 WARRANTY

DSE provides limited warranty to the equipment purchaser at the point of sale. For full details of any applicable warranty, you are referred to your original equipment supplier (OEM).

## 13 DISPOSAL

### 13.1 WEEE (WASTE ELECTRICAL AND ELECTRONIC EQUIPMENT)

Directive 2002/96/EC

If you use electrical and electronic equipment you must store, collect, treat, recycle and dispose of WEEE separately from your other waste.



### 13.2 ROHS (RESTRICTION OF HAZARDOUS SUBSTANCES)

Directive 2002/95/EC:2006

To remove specified hazardous substances (Lead, Mercury, Hexavalent Chromium, Cadmium, PBB & PBDE's)

Exemption Note: Category 9. (Monitoring & Control Instruments) as defined in Annex 1B of the WEEE directive will be exempt from the RoHS legislation. This was confirmed in the August 2005 UK's Department of Trade and Industry RoHS REGULATIONS Guide (Para 11).

Despite this exemption DSE has been carefully removing all non RoHS compliant components from our supply chain and products.

When this is completed a Lead Free & RoHS compatible manufacturing process will be phased into DSE production.

This is a process that is almost complete and is being phased through different product groups.

## 14 APPENDIX

### 14.1 CAN INTERFACE

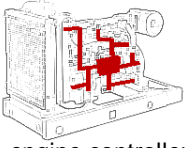

44x0-xxx-02 Modules are fitted with the CAN interface and are capable of receiving engine data from engine CAN controllers compliant with the CAN standard.

CAN enabled engine controllers monitor the engines operating parameters such as engine speed, oil pressure, engine temperature (among others) in order to closely monitor and control the engine. The industry standard communications interface (CAN) transports data gathered

by the engine controller interface (CAN). This allows generator controllers such as the DSE 60xx to access these engine parameters with no physical connection to the sensor device.

**NOTE:-** For further details for connections to CAN enabled engines and the functions available with each engine type, refer to the manual *Electronic Engines and DSE Wiring*. Part No. 057-004

## 14.2 COMMUNICATIONS OPTION CONNECTIONS

### 14.2.1 DESCRIPTION

The 60xx series configuration software allows the controller to communicate with a PC. The computer connects to the module as shown below and allows easy adjustment of the operating parameters and firmware update of the controller.

### 14.2.2 PC TO CONTROLLER (DIRECT) CONNECTION

To connect a 60xx series module to a PC the following items are required: -

- 60xx series module
- 60xx series configuration software (Supplied on configuration suite software CD or available from [www.deepseapl.com](http://www.deepseapl.com) free of charge).
- USB cable Type A to Type B.



**NOTE:-** The DC supply must be connected to the module for configuration by PC.

**NOTE:-** Refer to 60xx software Manual for further details on configuring the module by PC.

## 14.3 ENCLOSURE CLASSIFICATIONS

### IP CLASSIFICATIONS

60xx series specification under BS EN 60529 Degrees of protection provided by enclosures

**IP65** (Front of module when module is installed into the control panel with the supplied sealing gasket).

**IP42** (front of module when module is installed into the control panel WITHOUT being sealed to the panel)

First Digit	Second Digit
Protection against contact and ingress of solid objects 0 No protection	Protection against ingress of water 0 No protection
1 Protected against ingress solid objects with a diameter of more than 50 mm. No protection against deliberate access, e.g. with a hand, but large surfaces of the body are prevented from approach.	1 Protection against dripping water falling vertically. No harmful effect must be produced (vertically falling drops).
2 Protected against penetration by solid objects with a diameter of more than 12 mm. Fingers or similar objects prevented from approach.	2 Protection against dripping water falling vertically. There must be no harmful effect when the equipment (enclosure) is tilted at an angle up to 15° from its normal position (drops falling at an angle).
3 Protected against ingress of solid objects with a diameter of more than 2.5 mm. Tools, wires etc. with a thickness of more than 2.5 mm are prevented from approach.	3 Protection against water falling at any angle up to 60° from the vertical. There must be no harmful effect (spray water).
4 Protected against ingress of solid objects with a diameter of more than 1 mm. Tools, wires etc. with a thickness of more than 1 mm are prevented from approach.	4 Protection against water splashed against the equipment (enclosure) from any direction. There must be no harmful effect (splashing water).
5 Protected against harmful dust deposits. Ingress of dust is not totally prevented but the dust must not enter in sufficient quantity to interface with satisfactory operation of the equipment. Complete protection against contact.	5 Protection against water projected from a nozzle against the equipment (enclosure) from any direction. There must be no harmful effect (water jet).
6 Protection against ingress of dust (dust tight). Complete protection against contact.	6 Protection against heavy seas or powerful water jets. Water must not enter the equipment (enclosure) in harmful quantities (splashing over).

**NEMA CLASSIFICATIONS**

**60xx series NEMA Rating (Approximate)**

12 (Front of module when module is installed into the control panel with the optional sealing gasket).

2 (front of module when module is installed into the control panel WITHOUT being sealed to the panel)

 **NOTE: - There is no direct equivalence between IP / NEMA ratings. IP figures shown are approximate only.**

1 <b>IP30</b>	Provides a degree of protection against contact with the enclosure equipment and against a limited amount of falling dirt.
2 <b>IP31</b>	Provides a degree of protection against limited amounts of falling water and dirt.
3 <b>IP64</b>	Provides a degree of protection against windblown dust, rain and sleet; undamaged by the formation of ice on the enclosure.
3R <b>IP32</b>	Provides a degree of protection against rain and sleet;; undamaged by the formation of ice on the enclosure.
4 (X) <b>IP66</b>	Provides a degree of protection against splashing water, windblown dust and rain, hose directed water; undamaged by the formation of ice on the enclosure. (Resist corrosion).
12/12K <b>IP65</b>	Provides a degree of protection against dust, falling dirt and dripping non corrosive liquids.
13 <b>IP65</b>	Provides a degree of protection against dust and spraying of water, oil and non corrosive coolants.

This page is intentionally blank.

This page is blank intentionally.